

ZFV-C

**Smart Sensor
with Ultra-High-Speed Color
CCD Cameras**

User's Manual

OMRON

Introduction

This manual provides information regarding functions, performance and operating methods that are required for using the sensor.

When using the ZFV-C Smart Sensor, be sure to observe the following:

- The ZFV-C Smart Sensor must be operated by personnel knowledgeable in electrical engineering.
- To ensure correct use, please read this manual thoroughly to deepen your understanding of the product.
- Please keep this manual in a safe place so that it can be referred to whenever necessary.

INTRODUCTION	APPLICATION CONSIDERATIONS (Please Read)	Introduction
SECTION 1	FEATURES	Section 1
SECTION 2	INSTALLATION & CONNECTION	Section 2
SECTION 3	FUNCTIONS AND OPERATIONS TO BE USED	Section 3
SECTION 4	SETTING OF INSPECTION CONDITION	Section 4
SECTION 5	SETTING ADDITIONAL FUNCTIONS	Section 5
SECTION 6	APPENDIX	Section 6
SECTION 7	APPLICATION AND SETTING	Section 7

User's Manual

Smart Sensor
with Ultra-High-Speed Color CCD Cameras
ZFV-C Series

READ AND UNDERSTAND THIS DOCUMENT

Please read and understand this document before using the products. Please consult your OMRON representative if you have any questions or comments.

WARRANTY

OMRON's exclusive warranty is that the products are free from defects in materials and workmanship for a period of one year (or other period if specified) from date of sale by OMRON.

OMRON MAKES NO WARRANTY OR REPRESENTATION, EXPRESS OR IMPLIED, REGARDING NON-INFRINGEMENT, MERCHANTABILITY, OR FITNESS FOR PARTICULAR PURPOSE OF THE PRODUCTS. ANY BUYER OR USER ACKNOWLEDGES THAT THE BUYER OR USER ALONE HAS DETERMINED THAT THE PRODUCTS WILL SUITABLY MEET THE REQUIREMENTS OF THEIR INTENDED USE. OMRON DISCLAIMS ALL OTHER WARRANTIES, EXPRESS OR IMPLIED.

LIMITATIONS OF LIABILITY

OMRON SHALL NOT BE RESPONSIBLE FOR SPECIAL, INDIRECT, OR CONSEQUENTIAL DAMAGES, LOSS OF PROFITS OR COMMERCIAL LOSS IN ANY WAY CONNECTED WITH THE PRODUCTS, WHETHER SUCH CLAIM IS BASED ON CONTRACT, WARRANTY, NEGLIGENCE, OR STRICT LIABILITY.

In no event shall responsibility of OMRON for any act exceed the individual price of the product on which liability is asserted.

IN NO EVENT SHALL OMRON BE RESPONSIBLE FOR WARRANTY, REPAIR, OR OTHER CLAIMS REGARDING THE PRODUCTS UNLESS OMRON'S ANALYSIS CONFIRMS THAT THE PRODUCTS WERE PROPERLY HANDLED, STORED, INSTALLED, AND MAINTAINED AND NOT SUBJECT TO CONTAMINATION, ABUSE, MISUSE, OR INAPPROPRIATE MODIFICATION OR REPAIR.

SUITABILITY FOR USE

THE PRODUCTS CONTAINED IN THIS DOCUMENT ARE NOT SAFETY RATED. THEY ARE NOT DESIGNED OR RATED FOR ENSURING SAFETY OF PERSONS, AND SHOULD NOT BE RELIED UPON AS A SAFETY COMPONENT OR PROTECTIVE DEVICE FOR SUCH PURPOSES.

Please refer to separate catalogs for OMRON's safety rated products.

OMRON shall not be responsible for conformity with any standards, codes, or regulations that apply to the combination of products in the customer's application or use of the product.

At the customer's request, OMRON will provide applicable third party certification documents identifying ratings and limitations of use that apply to the products. This information by itself is not sufficient for a complete determination of the suitability of the products in combination with the end product, machine, system, or other application or use.

The following are some examples of applications for which particular attention must be given. This is not intended to be an exhaustive list of all possible uses of the products, nor is it intended to imply that the uses listed may be suitable for the products:

- Outdoor use, uses involving potential chemical contamination or electrical interference, or conditions or uses not described in this document.
- Nuclear energy control systems, combustion systems, railroad systems, aviation systems, medical equipment, amusement machines, vehicles, safety equipment, and installations subject to separate industry or government regulations.
- Systems, machines, and equipment that could present a risk to life or property.

Please know and observe all prohibitions of use applicable to the products.

NEVER USE THE PRODUCTS FOR AN APPLICATION INVOLVING SERIOUS RISK TO LIFE OR PROPERTY WITHOUT ENSURING THAT THE SYSTEM AS A WHOLE HAS BEEN DESIGNED TO ADDRESS THE RISKS, AND THAT THE OMRON PRODUCT IS PROPERLY RATED AND INSTALLED FOR THE INTENDED USE WITHIN THE OVERALL EQUIPMENT OR SYSTEM.

PERFORMANCE DATA

Performance data given in this document is provided as a guide for the user in determining suitability and does not constitute a warranty. It may represent the result of OMRON's test conditions, and the users must correlate it to actual application requirements. Actual performance is subject to the OMRON Warranty and Limitations of Liability.

CHANGE IN SPECIFICATIONS

Product specifications and accessories may be changed at any time based on improvements and other reasons.

It is our practice to change model numbers when published ratings or features are changed, or when significant construction changes are made. However, some specifications of the product may be changed without any notice. When in doubt, special model numbers may be assigned to fix or establish key specifications for your application on your request. Please consult with your OMRON representative at any time to confirm actual specifications of purchased products.

DIMENSIONS AND WEIGHTS

Dimensions and weights are nominal and are not to be used for manufacturing purposes, even when tolerances are shown.

ERRORS AND OMISSIONS

The information in this document has been carefully checked and is believed to be accurate; however, no responsibility is assumed for clerical, typographical, or proofreading errors, or omissions.

PROGRAMMABLE PRODUCTS

OMRON shall not be responsible for the user's programming of a programmable product, or any consequence thereof.

COPYRIGHT AND COPY PERMISSION

This document shall not be copied for sales or promotions without permission.

This document is protected by copyright and is intended solely for use in conjunction with the product. Please notify us before copying or reproducing this document in any manner, for any other purpose. If copying or transmitting this document to another, please copy or transmit it in its entirety.

Meanings of Signal Words

The following signal words are used in this manual.



Indicates a potentially hazardous situation which, if not avoided, will result in minor or moderate injury, or may result in serious injury or death. Additionally there may be significant property damage.

Meanings of Alert Symbols

The following alert symbols are used in this manual.



Indicates general prohibitions for which there is no specific symbol.



Indicates the possibility of laser radiation.

Alert Statements in This Manual

The following alert statements apply to the products in this manual. Each alert statement also appears at the locations needed in this manual to attract your attention.



This product is not designed or rated for ensuring safety of persons.
Do not use it for such purposes.



Since ZFV-SC50 emits a visible light that may have an adverse affect on the eyes, do not stare directly into the light emitted from the sensor head. If a specular object is used, take care not to allow reflected light enter your eyes.



Precautions for Safe Use

Please observe the following precautions for safe use of the products.

(1) Installation Environment

- Do not use the product in environments where it can be exposed to inflammable/explosive gas.
- Install the Amplifier Unit in such a way that the ventilation holes are not blocked.
- To secure the safety of operation and maintenance, do not install the product close to high-voltage devices and power devices.
- During installation, make sure that screws are tightened firmly.

(2) Power Supply and Wiring

- The supply voltage must be within the rated range (DC24 V + 10 %, -15 %).
- Reverse connection of the power supply is not allowed.
- Open-collector outputs should not be short-circuited.
- Use the power supply within the rated load.
- High-voltage lines and power lines must be wired separately from this product. Wiring them together or placing them in the same duct may cause induction, resulting in malfunction or damage.

(3) Others

- Do not attempt to dismantle, repair, modify, pressurize or incinerate the product.
- Dispose of this product as industrial waste.
- Should you notice any abnormalities, immediately stop use, turn OFF the power supply, and contact your OMRON representative.

Precautions for Correct Use

Please observe the following precautions to prevent failure to operate, malfunctions, or undesirable effects on product performance.

(1) Installation Location

Do not install the product in locations subjected to the following conditions:

- Ambient temperature outside the rating
- Rapid temperature fluctuations (causing condensation)
- Relative humidity outside the range of 35 to 85 %
- Presence of corrosive or flammable gases
- Presence of dust, salt, or iron particles
- Direct vibration or shock
- Reflection of intense light (such as other laser beams or electric arc-welding machines)
- Direct sunlight or near heaters
- Water, oil, or chemical fumes or spray
- Strong magnetic or electric field

(2) Power Supply and Wiring

- Supply power from a DC power supply unit that has a countermeasure (safety ultra-low voltage circuit) built-in for preventing high voltages from occurring.
- When using a commercially available switching regulator, make sure that the FG terminal is grounded.
- If surge currents are present in the power lines, connect surge absorbers that suit the operating environment.
- Before turning ON the power after the product is connected, make sure that the power supply voltage is correct, there are no incorrect connections (e.g. load short-circuit) and the load current is appropriate. Incorrect wiring may result in breakdown of the product.
- Before connecting/disconnecting the Sensor Head, make sure that the Smart Sensor is turned OFF. The Smart Sensor may break down if the Sensor Head is connected or disconnected while the power is ON.
- Use extension cord ZFV-XC_B(R)V2 sold separately for extending the cord between the sensor head and amplifier unit. Two ZFV-XC_B(R)V2 cords can be coupled together to extend the cord length. In addition, use a robot cable type extension cord (ZFV-XC_BRV2) at locations where the cord bends, to prevent damage to the cord.
- Use only combinations of Sensor Heads and Sensor Controllers specified in this manual.
- Do not turn OFF the power in the following cases.
 - Immediately after the mode is switched from MENU or ADJ mode to RUN mode
 - While teaching operation using the parallel signal is in progressDo not turn off the power until the ENABLE signal is turned ON. Failure to do so may initialize the bank data.

- Although the LCD display panel is manufactured by precision technology, it may have a minute amount of faulty pixels. This is due to the panel structure, and the panel is not faulty.

(3) Orientation when Installing the Amplifier Unit

To improve heat radiation, install the Sensor Controller only in the orientation shown below.

Right

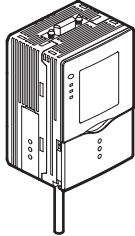

Do not install the Amplifier Unit in the following orientations.

Wrong

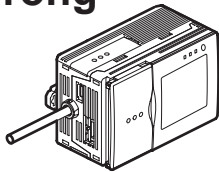

Wrong

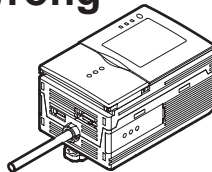

(4) Maintenance and Inspection

- Do not use thinner, Alcohol, benzene, acetone or kerosene to clean the Sensor Head and Amplifier Unit.
- If large dust particles adhere to the front filter of the Sensor Head, use a blower brush (used to clean camera lenses) to blow them off. Do not blow the dust particles with your mouth.
- To remove smaller dust particles, wipe gently with a soft cloth. Do not use excessive force to wipe off dust particles. Scratches on the filter may cause errors.
- Should you notice any abnormalities, immediately stop use, turn OFF the power supply, and contact your OMRON representative.

(5) Ventilation Film

- Do not peel off or probe the ventilation film with a sharp-pointed object. If you do, the specifications of the protective structure may no longer be satisfied.
- Do not block the ventilation film. Doing so might cause the front panel to be condensed.

(6) Optional Lighting Connector

When no optional lighting unit is used, make sure that the connector is covered with the cap. If no, the specifications of the protective structure may no longer be satisfied.

Editor's Note

Page Format

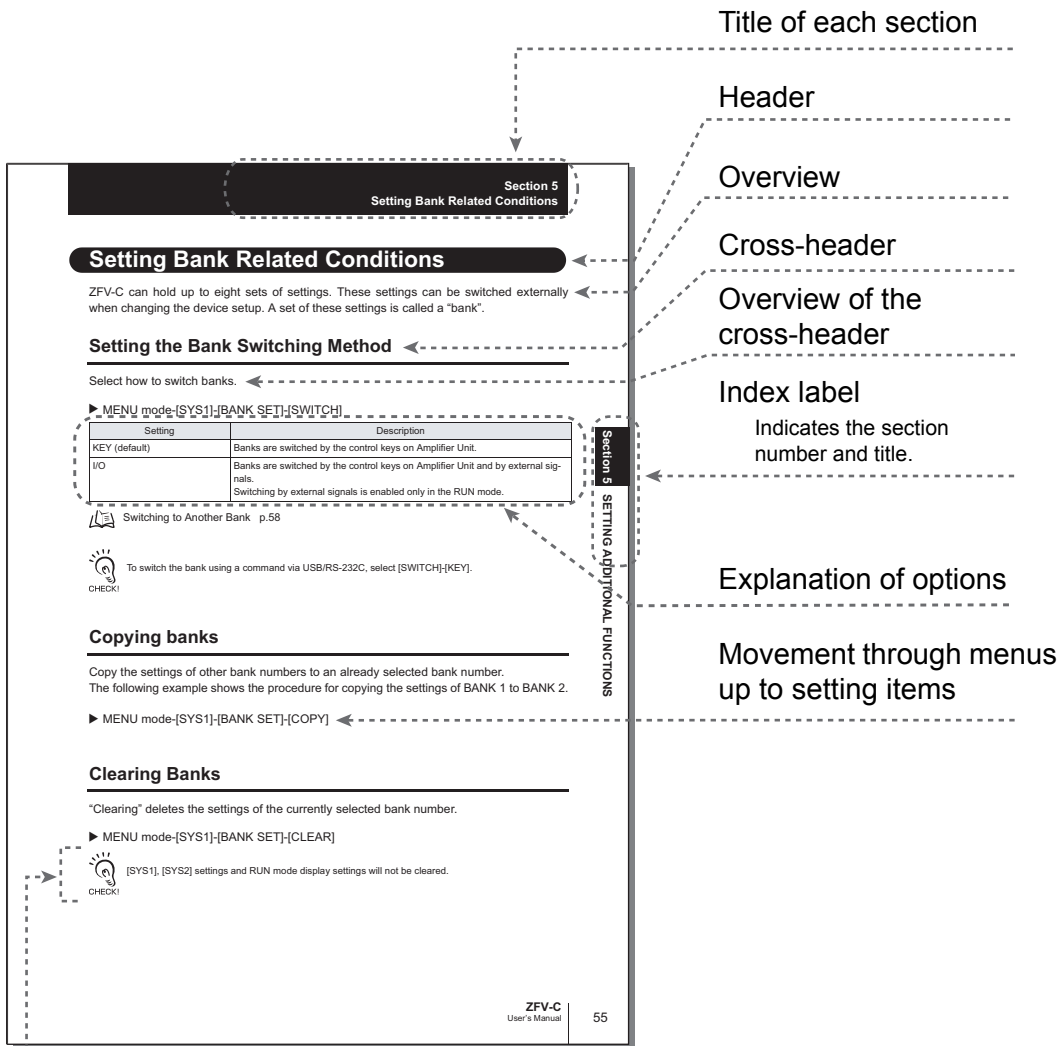

Supplementary Explanation

Helpful information regarding operation and reference pages are introduced here using symbols.



*This page has been made purely for explanatory purposes and does not exist.

■ Meaning of Symbols

Menu items that are displayed on the Amplifier Unit's LCD screen are enclosed by brackets [].

■ Visual Aids



CHECK!

Indicates points that are important to ensure full product performance, such as operational precautions and application procedures.



Indicates pages where related information can be found.



Indicates information helpful in operation.

EXP MENU

Indicates functions that can be set only when the setup menu has been switched to EXP menu.

CONTENTS

Meanings of Signal Words	5
Meanings of Alert Symbols	5
Alert Statements in This Manual	5
Precautions for Safe Use	6
Precautions for Correct Use	7
Editor's Note	9
Page Format	9
CONTENTS	11
Menu Hierarchy	16
Section 1 FEATURES	19
Features	20
System Configuration	21
Part Names and Functions	24
Operation Mode	27
Setting Flow	28
Section 2 INSTALLATION & CONNECTION	31
About Installation and Connection	32
Amplifier Unit	32
Installing the Amplifier Unit	32
Gang-Mounting	36
About the I/O Cable	39
Timing Charts	42
Sensor Head	45
Affixing LED Warning Labels	45
Installing the Mounting Fixture	45
Installing the Sensor Head	47
Connecting the Sensor Head	51

Section 3 FUNCTIONS AND OPERATIONS TO BE USED	53
<hr/>	
Switching the Display Content	54
Characters Displayed on the LCD Monitor and Their Meanings	55
Key Operations for RUN Mode	57
Switching to Another Bank	58
<hr/>	
Section 4 SETTING OF INSPECTION CONDITION	59
<hr/>	
Basic Knowledge for Operation	60
Displays of MENU/ADJ Mode and Key Operations	60
Teaching Flow	61
Inspecting by Pattern (PATTERN)	62
Basic Setting Procedure	63
CUSTOM Menu	64
Inspecting by the Size (Area)	66
Basic Setting Procedure	68
CUSTOM Menu	69
Inspecting by Color (HUE)	70
Basic Setting Procedure	70
Inspecting by Width (WIDTH)	72
Basic Setting Procedure	72
CUSTOM Menu	73
Inspecting by Position (POSITION)	75
Basic Setting Procedure	75
CUSTOM Menu	76
Inspecting by Count (COUNT)	78
Basic Setting Procedure	78
CUSTOM Menu	79
Inspecting by Brightness (BRIGHT)	81
Basic Setting Procedure	81
CUSTOM Menu	82
Detecting Presence of Character String (CHARA)	84
Basic Setting Procedure	85
CUSTOM Menu	87

Section 5 SETTING ADDITIONAL FUNCTIONS	91
Setting Image Acquisition Conditions	92
Adjusting Light Intensity and Shutter Speed	92
Changing the Image Display Position (Partial Function)	93
Increasing the Sensor Head Sensitivity	93
Setting Conditions Related to Bank	94
Copying Banks	94
Clearing Banks	95
Setting the Bank Switching Method	95
Setting the System Environment	96
Changing the Measurement Speed	96
Selecting the Measurement Timing	97
Selecting the Teaching Mode from an External Device	97
Setting Screen Display	97
Setting/Cancelling the Eco Mode	98
Changing Image Capture Timing on Teaching Screen	98
I/O Monitor Function	99
Correcting White Balance	100
Initializing the Setup Data	100
Initializing Measurement Data	101
Switching the Language	101
Checking the Version	101
Setting USB/RS-232C Communication Specifications	102
USB Connection	102
RS-232C Connection	103
Restricting Operations (Lock Function)	105
Setting the Lock Function	105
Starting/Cancelling the Lock Function	106
Lock Function during Gang-Mounting	106
Changing OUTPUT Signal Output Conditions	107
Selecting the ON Conditions	107
One-shot Output	107
Setting the ON Delay Time	108
Setting the OFF Delay Time	109

Setting for Amplifier Unit Gang-Mount	110
Specifying the Amplifier Unit to Input the Trigger	111
Setting the Presence of Sensor Head	111
Setting Output Content	111
Rules of Gang-Mounting	112
Data Route	113
Teaching Process when Gang-Mounting	114
Integrating Judgment Output	115
Restrictions when Gang-Mounting Amplifier Units	116
Section 6 APPENDIX	117
<hr/>	
Troubleshooting	118
Error Messages and Corrective Actions	119
Q&A	120
Specifications and External Dimensions	121
Sensor Head	121
Amplifier Unit	126
Panel Mount Adapters	128
Control Link Unit	129
Extension Cord	130
RS-232C Cable	131
Lighting Unit (Option)	132
LED Safety Precautions for Using Laser Equipment	135
Requirements from Regulations and Standards	136
Summary of Requirements to Manufactures	136
Summary of Requirements to User	138
Definitions of Laser Classification	139
Updating the Firmware	140
Flow of Firmware Update	140
Version upgrade information	145
Index	146

Section 7 APPLICATION AND SETTING	149
Inspecting for the Presence of Electronic Components (Pattern)	150
Detecting Mixed Varieties of Campaign Seals (Area)	152
Inspecting Entry of Workpieces of Wrong Color (HUE)	156
Explanation of Color Related Functions	158
Color Pickup Function	158
Hue Indication Number	159
Revision History	160

Menu Hierarchy

Items indicated by **EXP MENU** are displayed only when the EXP menu is selected.

MENU mode		Settings	Default	Selection/Setting Range	Page	
TEACH	ITEM	PATTERN	-	SEARCH, MATCH	p.62	
		AREA	-	AREA1, AREA2, AREA3	p.66	
		HUE	-	-	p.70	
		WIDTH	-	-	p.72	
		POSITION	-	-	p.75	
		COUNT	-	-	p.78	
		BRIGHT	-	-	p.81	
		CHARA	-	CHARA1, CHARA2	p.84	
	REG.	SIZE	-	↔, ↑↓	p.61	
		MOVE	-	↔, ↑↓	p.61	
	PICK (*1)	PICKAREA	-	-	p.61	
		PICKCOL	-	-	p.61	
	CUSTM EXP MENU	[PATTERN/SEARCH]	FILTER	AUTO	AUTO, RED, YELLOW, GREEN, CYAN, BLUE, MAGENTA, GRAY	p.65
			SEARCH AREA	-	↔, ↑↓, SIZE, MOVE	p.64
			ROTATION	±10°	±10°, ±20°, ±30°, ±45°	p.64
COL JUGE			OFF	OFF, ON	p.65	
LIGHT TEACH (*2)			ON	OFF, ON	p.65	
[PATTERN/MATCH]		FILTER	AUTO	Same as [PATTERN/SEARCH/FILTER]	p.65	
		SEARCH AREA	-	↔, ↑↓, SIZE, MOVE	p.64	
		COL JUGE	OFF	OFF, ON	p.65	
		LIGHT TEACH (*2)	ON	OFF, ON	p.65	
[AREA]:[AREA1/2]		LIGHT TEACH	ON	OFF, ON	p.65	
[AREA]:[AREA3]		FILTER	AUTO	Same as [PATTERN/SEARCH/FILTER]	p.65	
		COLOR	WHITE	WHITE, BLACK	p.69	
		BINARY	-	0 to 255, BLACK	p.69	
[WIDTH]		COL MODE	FILTER	PICKUP, FILTER	p.74	
		FILTER (*4)	AUTO	Same as [PATTERN/SEARCH/FILTER]	p.65	
		EDGE MODE	LIGHT	DARK, LIGHT	p.74	
		DIRECTION	↔	↑↓, ↔	p.74	
		LIGHT TEACH (*3)	ON	OFF, ON	p.65	
[POSITION]		COL MODE	FILTER	PICKUP, FILTER	p.74	
		FILTER (*4)	AUTO	Same as [PATTERN/SEARCH/FILTER]	p.65	
		EDGE SENSE	NORMAL	SENSITIVE, NORMAL, ROUGH	p.77	
		EDGE MODE	LIGHT	DARK, LIGHT	p.77	
		DIRECTION	→	↑, ↓, →, ←	p.77	
		LIGHT TEACH (*3)	ON	OFF, ON	p.65	
[COUNT]		COL MODE	FILTER	PICKUP, FILTER	p.74	
		FILTER (*4)	AUTO	Same as [PATTERN/SEARCH/FILTER]	p.65	
		EDGE MODE	LIGHT	DARK, LIGHT	p.80	
		DIRECTION	→	↓, →	p.80	
		LIGHT TEACH (*3)	ON	OFF, ON	p.65	

	Settings	Default	Selection/Setting Range	Page	
[BRIGHT]	FILTER	AUTO	Same as [PATTERN/SEARCH/FILTER]	p.65	
	METHOD	DENAVE	DENAVE, DENDEV	p.83	
[CHARA]:[CHARA1]	FILTER	AUTO	Same as [PATTERN/SEARCH/FILTER]	p.65	
	MODE	NONE	NONE, MODEL, EDGE	p.88	
	MODE DTL	MODEL	-	-	p.88
		EDGE MODE	DARK	LIGHT, DARK	p.89
	DIRECTION	→	↑, ↓, ←, →	p.89	
	SEARCH AREA	-	-	p.90	
[CHARA]:[CHARA2]	FILTER	AUTO	Same as [PATTERN/SEARCH/FILTER]	p.65	
	MODEL DIV	1LINE NORMAL	1LINE SHORT, 1LINE NORMAL 1LINE, LONG, 2LINE SHORT 2LINE NORMAL	p.87	
	MODE	EDGE	NONE, MODEL, EDGE	p.88	
	MODE DTL	MODEL	-	-	p.88
		EDGE MODE	DARK	LIGHT, DARK	p.89
	DIRECTION	↓	↑, ↓, ←, →	p.89	
	SEARCH AREA	-	-	p.90	
	STABLE	OFF	OFF, ON	p.90	
	BANK	BANK	BANK1	BANK1 to BANK8	p.94
	IMAGE	CONTRAST	AUTO (default)	-	p.92
FIX			SHUTTER	LIGHT (0000 to 5555) SHUTTER (1/500(*6), 1/1000, 1/1200, 1/1400, 1/1500, 1/2000, 1/2500, 1/3000, 1/4000, 1/8000)	p.92
DISP POS(*7)		-	-	p.93	
GAIN		x1	x1, x1.5, x2	p.93	
SYSTEM 1		BANKSET	COPY	-	BANK1 - BANK8
	CLEAR		-	-	p.95
	SWITCH		KEY	KEY, I/O	p.95
	SPEED	NORMAL	NORMAL, FAST, MAX	p.96	
	MEAS TYPE	TRIG	TRIG, CONTINUE	p.97	
	TEACH TYPE	STATIONARY	STATIONARY, MOVE	p.97	
	DISP COL	OK	GREEN	GREEN, RED, YELLOW, BLUE, WHITE	p.97
		NG	RED	GREEN, RED, YELLOW, BLUE, WHITE	p.97
		NORMAL	WHITE	GREEN, RED, YELLOW, BLUE, WHITE	p.97
		BACK	BLUE	GREEN, RED, YELLOW, BLUE, WHITE, BLACK	p.97
ECO MODE	ON	ON, OFF	p.98		

(*1) Displayed when [ITEM] - [AREA] is selected or when [ITEM] - [WIDTH], [POSITION] or [COUNT] is selected and then [CUSTOM] - [COL MODE] - [PICKCOL] is selected.

(*2) Displayed when [COL JUDGE] - [ON] is selected.

(*3) Displayed when [COL MODE] - [PICKCOL] is selected.

(*4) Displayed when [COL MODE] - [FILTER] is selected.

(*5) This menu is not displayed if ZFV-SC150/SC150W is connected.

(*6) "1/500" can be set only when the light intensity is set to "0000".

(*7) Displayed when [SPEED] - [FAST] or [MAX] is selected.

Settings	Default	Selection/Setting Range	Page
ON STATUS	NG ON	OK ON, NG ON	p.107
ONE SHOT	OFF	OFF, ON	p.107
ON DELAY	0	0 to 255	p.108
OFF DELAY	0	0 to 255	p.109
OUTPUT TIME	0	0 to 255	p.108
TEACH IMAGE	THROUGH	THROUGH, FREEZE	p.98
I/O MON	-	-	p.99
COM			
LENGTH	8	7, 8	p.102
PARITY	OFF	OFF, ODD, EVEN	p.102
STOP BIT	1	1, 2	p.102
BAUDRATE	38400	9600, 19200, 38400, 57600, 115200	p.102
NODE	0	0 to 16	p.102
DELMIT	CR	CR, LF, CR+LF	p.102
WHITE BALANCE	-	-	p.100
ALL CLEAR	-	-	p.100
MEAS CLEAR	-	-	p.101
LANGUAGE	-	ENGLISH, JAPANESE	p.101
VERSION	-	-	p.101
LOCK			
MODE SWITCH	LOCK OFF	LOCK OFF, LOCK ON	p.105
KEY	LOCK OFF	LOCK OFF, LOCK ON	p.105
TEACH IN	LOCK OFF	LOCK OFF, LOCK ON	p.105
PASS NUMBER	0000	0~9999	p.105
LINKSET (*8)			
OUTPUT	EACH	ALL, EACH	p.111
TRIG	I/O	I/O, LINK	p.111
HEAD	USE	USE, NOT USE	p.111

(*8) This menu is displayed only when Amplifier Units are gang-mounted.

Section 1

FEATURES

☒ Features	20
☒ System Configuration	21
☒ Part Names and Functions	24
☒ Operation Mode	27
☒ Setting Flow	28

Features

The ZFV-C sensor recognizes objects by its "surface". Updating from the conventional monochrome sensor to this color sensor not only widens the choice of applications but also enables stable measurement.

The ZFV-C also uses a 250,000-pixel CCD equivalent to that of a conventional machine vision sensor. This allows presence detection and recognition of different objects, which have up till now been performed by a human, to be executed fast and accurately.

Example: Inspection of Campaign Seals

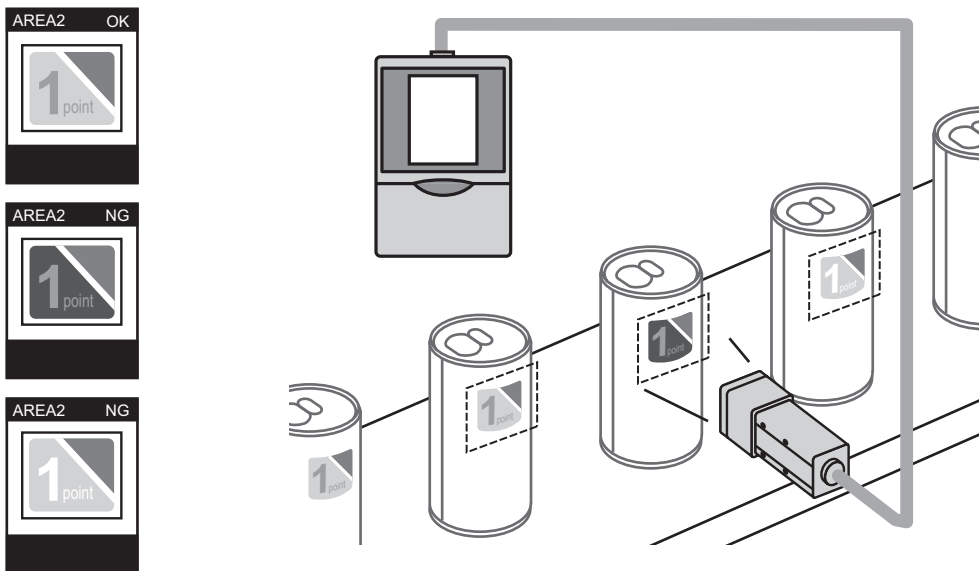

System Configuration

Basic Configuration

Sensor Head

Detects workpieces as images.

- Narrow view type (Field of vision 5 to 9 mm) ZFV-SC10
- Standard view type (Field of vision 10 to 50 mm) ZFV-SC50/SC50W
- Wide view type (Field of vision 50 to 90 mm) ZFV-SC90/SC90W
- Ultra wide view type (Field of vision 90 to 150 mm) ZFV-SC150/SC150W

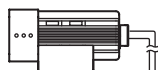

Amplifier Unit

Used for confirming images and menus, performing measurement processing, and outputting the result of processing.
ZFV-CA40/CA45



Power Supply

- 24 VDC (+10%, -15%)
Recommended OMRON power supply
- (1) When 1 amplifier unit is connected S82K-03024 (DC24V, 1.3A)
 - (2) When 2 or more amplifier units are connected The power supply given in (1) must be provided for each amplifier unit.

Peripheral Device

Lighting Unit (Option)

Used when the amount of light by the built-in type lighting device is insufficient or when another lighting method like back lighting is required.

This unit can be mounted to the sensor head ZFV-SC50/SC50W/SC90/SC90W with a single motion, and no power supply is required for the unit.

- Bar lighting ZFV-LTL01
- Bar double-lighting ZFV-LTL02
- Bar low-angle lighting ZFV-LTL04
- Light Source for Through-beam Lighting ZFV-LTF01

Sensor Head Extension Cable



ZFV-XC3BV2(3 m)/XC8BV2*(8 m)/XC3BRV2 (Robot cable type, 3 m)

Used between a Sensor Head and Amplifier Unit. Up to two extension cords can be coupled together for each sensor head to extend the cord length.

There are no restrictions on combinations of the two extension cords.

*“ZFV-XC8BV2” can be used with the sensor heads “ZFV-SC10”, “-SC50” and “-SC50W” only.

Personal Computer

USB



- Communication by commands
- Saving/loading setting data and image data by Smart Monitor ZFV Tool

For the Smart Monitor ZFV Tool, please contact your OMRON representative.

RS-232C

Programmable Controller



Communication by commands

[For connecting a programmable controller]
ZS-XPT2
[For connecting a PC]
ZS-XRS2

■ Amplifier unit expansion

When amplifier units are gang-mounted, a wider range of applications can be supported by simultaneous processing of multiple areas and combination of measurement items can be combined.

 Setting for Amplifier Unit Gang-Mount p.110

● Example 1

In this configuration, multiple areas in an image from a single Sensor Head are inspected and multiple inspection items are performed.

Example) Inspection of the number of leads

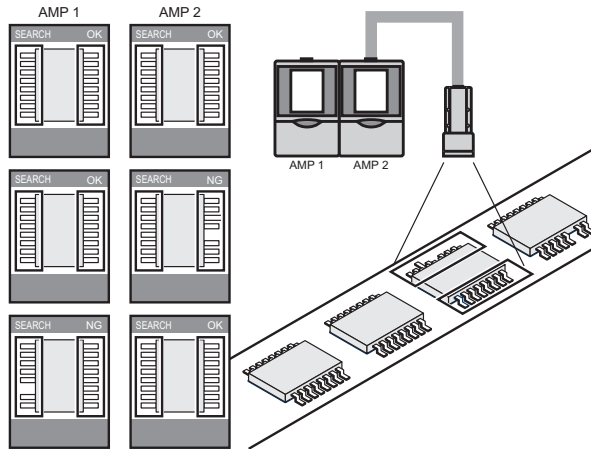

● Example 2

In this configuration, multiple sensor heads are used to simultaneously inspect multiple locations on a workpiece.

When the TRIG signal is input to an amplifier from a single specified Amplifier Unit, the connected Amplifier Unit starts sensing immediately. The results of sensing are integrated on the Amplifier Unit to which the TRIG signal was input, and a total judgment result is output.

Example) Alignment of products

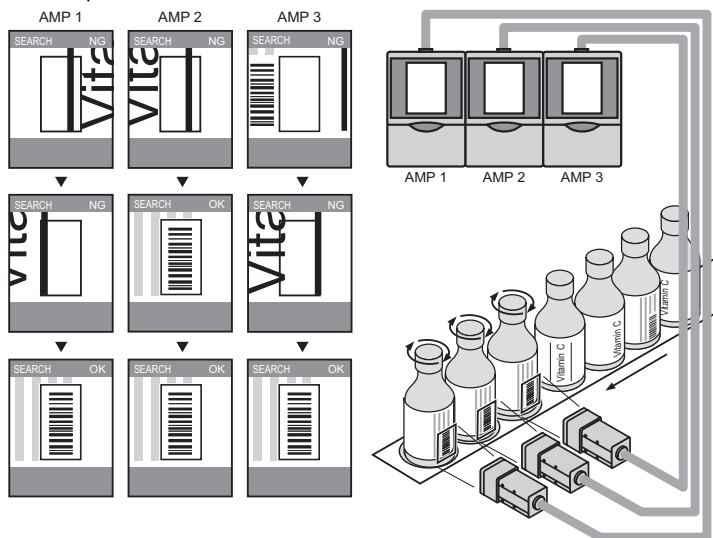

● **Example 3**

Measurement images can be logged by connecting to data storage unit ZS-DSU. Set NG occurrence as a trigger to log before/after images and measurement values. This is useful for investigating the cause of defectives. Logged data is saved to the memory card inserted into the data storage unit, and can be easily loaded to a computer.

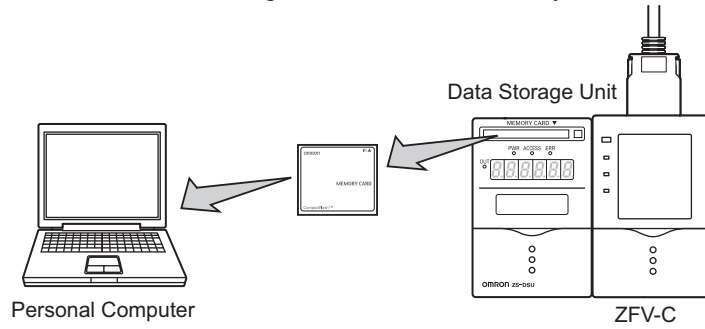

In addition, up to 128 bank data can be saved in the memory card inserted into the data storage unit. Bank data can be transferred from the data storage unit to ZFV as needed for the device setup.





For details, refer to the data storage unit ZS-DSU User's Manual.

Part Names and Functions

The following describes the names and functions of parts on the Amplifier Unit and Sensor Head.

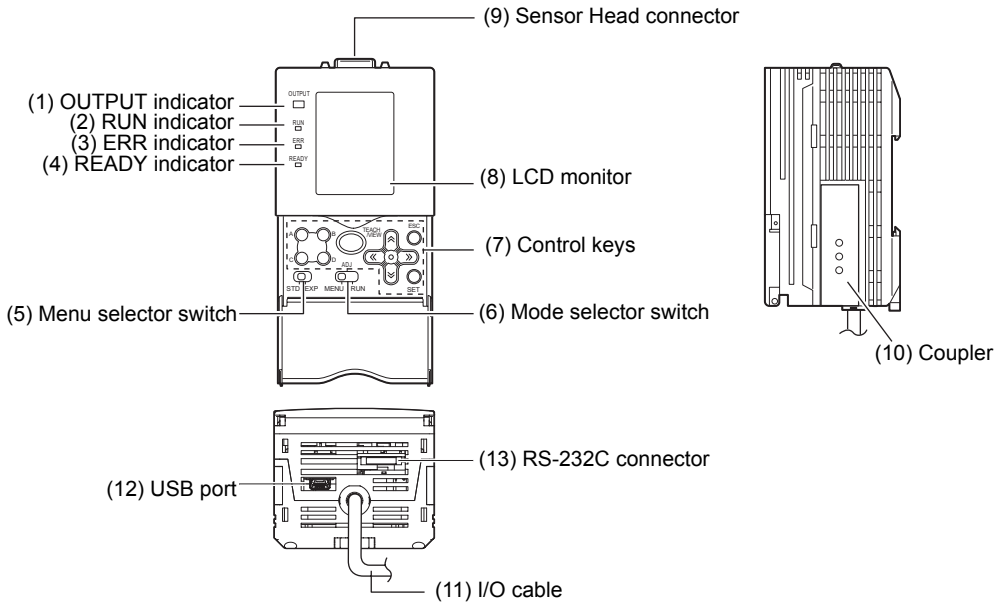
■ Amplifier unit



No.	Name	Description
(1)	OUTPUT indicator	The Output indicator lits when the OUTPUT signal turns ON.
(2)	RUN indicator	The RUN indicator turns ON in the RUN mode.
(3)	ERROR indicator	The ERROR indicator turns ON when an error is generated.
(4)	READY indicator	The READY indicator lits after the amplifier unit starts up correctly.
(5)	Menu selector switch	This switch is for the setup menu. STDStandard menu. Select this when setting the minimum required items for measurement. EXPExpert menu. Select this item when making a more detailed setup.
(6)	Mode selector switch	This switch selects the operating mode. MENUSelect this mode when setting measurement conditions. ADJSelect this mode when adjusting the judgment threshold value. RUNSelect this mode when performing measurement. The judgment results is output from the I/O cables only when the RUN mode is currently selected.
(7)	Control keys	The Control Keys are for setting measurement conditions and other information.  Key Operations p.57, p.60
(8)	LCD monitor	The LCD monitor displays setup menus and images captured from the Sensor Head.

No.	Name	Description
(9)	Sensor Head connector	This connector connects the Sensor Head.
(10)	Coupler	This connector is used to connect two or more Amplifier Units. It is located on both sides of the Amplifier Unit.
(11)	I/O cable	The I/O cable connects the Amplifier Unit to the power supply and external devices, such as timing sensors or programmable controllers.
(12)	USB port	To connect a personal computer, connect a USB cable to this connector. Before connecting/disconnecting the USB cable, make sure that no measurement is in progress.
(13)	RS-232C connector	To connect a programmable controller or personal computer, connect a RS-232C cable to this connector. The following dedicated RS-232C cable shown below must be used. Use of a RS-232C other than the one given below may result in malfunction or damage. [For connecting a programmable controller] ZS-XPT2 [For connecting a PC] ZS-XRS2

■ Sensor Head

ZFV-SC10

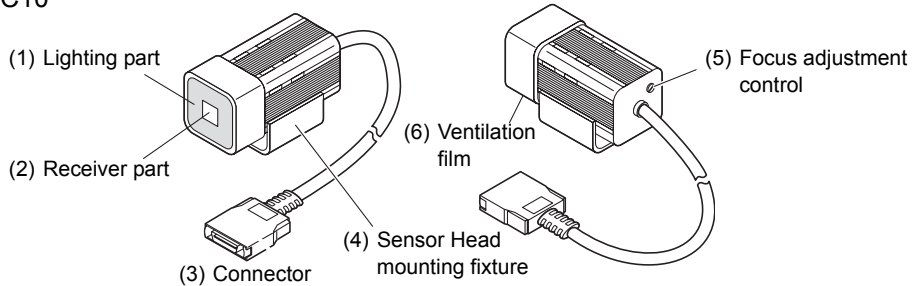

ZFV-SC50/SC50W

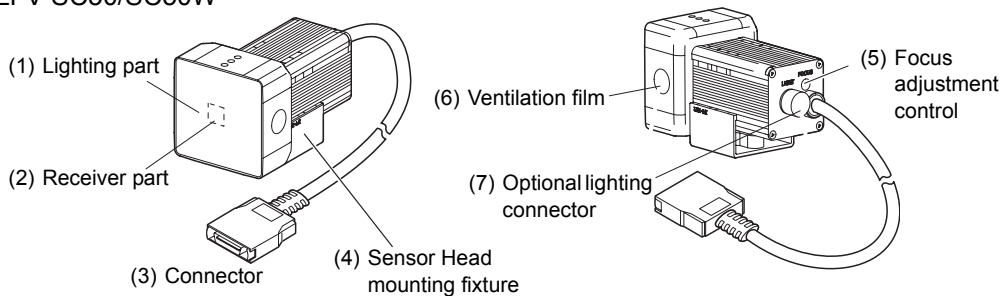

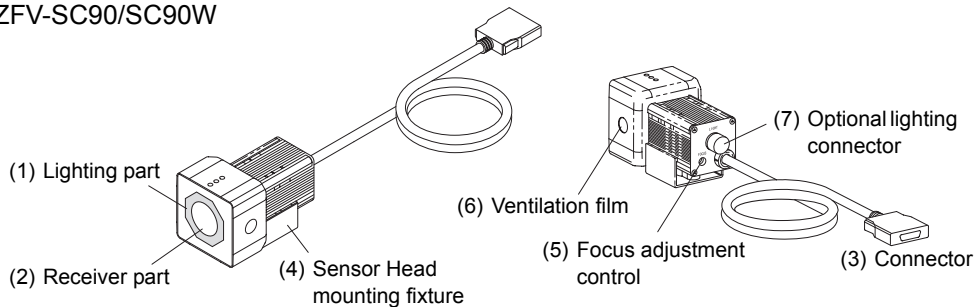

ZFV-SC90/SC90W

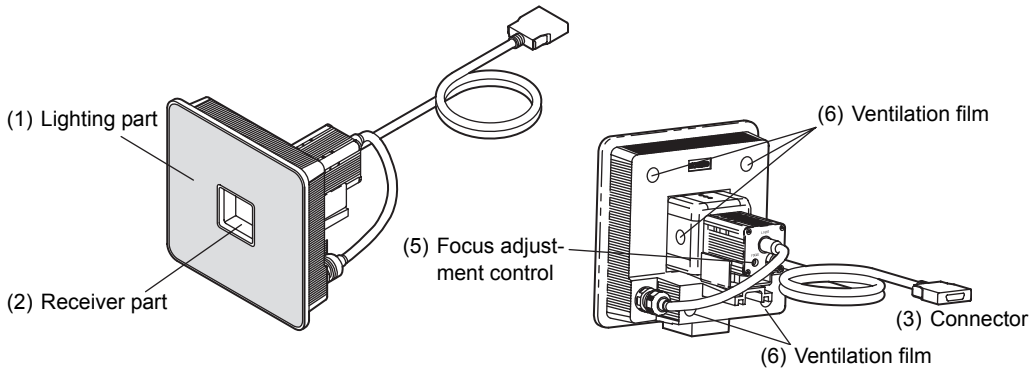

■ ZFV-SC150/SC150W



No.	Name	Description
(1)	Lighting part	This area emits light.
(2)	Receiver part	This area captures a image.
(3)	Connector	This connector is connected to the Amplifier Unit.
(4)	Sensor Head mounting fixture	This fixture is for mounting the Sensor Head. This fixture can be mounted on all of the four mounting surfaces.
(5)	Focus adjustment control	This control is used for adjusting the focus of the image.
(6)	Ventilation film	This film prevents the front panel from condensation.  <ul style="list-style-type: none"> Do not peel off or probe the ventilation film with a sharp-pointed object. If you do that the protective structure rating may no longer be satisfied. <p>CHECK!</p> <ul style="list-style-type: none"> Do not cover the ventilation film rating. Doing so might cause the front panel to be condensed.
(7)	Optional lighting connector	This connector is used to connect an optional lighting unit. (ZFV-SC50, ZFV-SC90)  <p>When no optional lighting unit is used, make sure that the connector is covered with the cap. If not, water-resistant performance will be deteriorated.</p> <p>CHECK!</p>

Operation Mode

There are 3 ZFV-C operating modes as follows. Switch to the mode that you meet, before you start operation.

To switch the operating mode, use the mode switch.

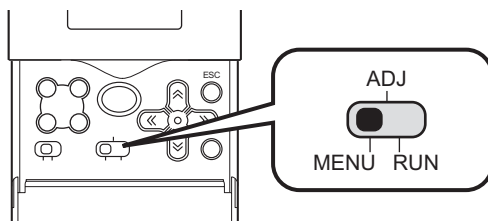

Mode	Description
MENU mode	This mode is for executing teaching or setting up the measurement conditions.
ADJ mode	This mode is for setting the judgment threshold values.
RUN mode	This mode is for performing actual measurement.

There are two setup menus in the MENU mode. Switch the menu according to your specific requirements.

To switch the menu, use the menu selector switch.

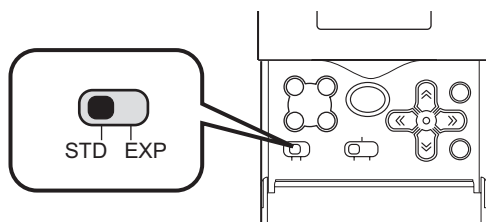

Setup Menu	Description	Top Screen
STD menu	This is the standard menu. First, set the measurement conditions in this menu.	
EXP menu	This is the expert menu. Switch to this menu to make a more advanced setup.	

Menu Hierarchy Differences by Menus p.16

Setting Flow

Preparation for Measurement

Installation and Connection

Connect the sensor head and amplifier unit.



Section 2
INSTALLATION & CONNECTION p.32

▼ Turn ON the power.

Adjustment of Image

Adjusts the image's focus.



Section 2
INSTALLATION & CONNECTION p.49

Setting Measurement Conditions, Checking Settings and Starting Measurement

Executing Teaching

Execute teaching, and set the judgment criteria.



Section 4
SETTING OF INSPECTION CONDITION
Teaching Flow p.61



Section 7
APPLICATION AND SETTING p.149

Adjusting Threshold Values

Adjust the threshold values used to make judgment on measured values.



Section 4
SETTING OF INSPECTION CONDITION p.59

Performing Measurement





Section 3
FUNCTIONS AND OPERATIONS TO BE USED p.54







CHECK!

Measurement conditions that you have set are saved to the amplifier unit "when external TEACH signal teaching is successful" or "when switched to RUN mode". When the TEACH key is pressed at the teaching screen to teach, conditions that you have set will not be saved unless switched to RUN mode once. Changed contents including teaching results are cleared when switching off without saving.

Advanced Operation

Customizing Measurement conditions	 Section 4 SETTING OF INSPECTION CONDITION p.59
Changing Image Acquisition Conditions	 Section 5 SETTING ADDITIONAL FUNCTIONS p.92







Making Settings When Required

Setting Banks Use two or more banks for setup changes.	 Section 3 FUNCTIONS AND OPERATIONS TO BE USED Switching to Another Bank p.58  Section 5 SETTING ADDITIONAL FUNCTIONS Setting Conditions Related to Bank p.94
Setting the System Environment	 Section 5 SETTING ADDITIONAL FUNCTIONS p.96
Changing OUTPUT Signal Output Conditions	 Section 5 SETTING ADDITIONAL FUNCTIONS p.107
Setting USB/RS-232C Communications Specifications	 Section 5 SETTING ADDITIONAL FUNCTIONS p.102

Other Functions

Switching the Display Content	 Section 3 FUNCTIONS AND OPERATIONS TO BE USED p.54
Clearing Data	Section 5 SETTING ADDITIONAL FUNCTIONS Initializing the Setup Data p.100 Initializing Measurement Data p.101 Clearing Banks p.95

Troubleshooting

 When the Smart Sensor Does Not Operate Correctly  Troubleshooting p.118	 When an Error Message Appears  Error Messages and Corrective Actions p.119
 When You are Not Sure  Q&A p.120	

MEMO

Section 2

INSTALLATION & CONNECTION

☒	About Installation and Connection	32
☒	Amplifier Unit	32
	Installing the Amplifier Unit	32
	Gang-Mounting	36
	About the I/O Cable	39
	Timing Charts	42
☒	Sensor Head	45
	Affixing LED Warning Labels	45
	Installing the Mounting Fixture	45
	Installing the Sensor Head	47
	Connecting the Sensor Head	51

About Installation and Connection

■ Checking the installation environment

Read “Precautions for Safe Use” at the beginning of this manual, and check the installation environment.

■ Checking the installation place

Read “Precautions for Correct Use” at the beginning of this manual, and check the installation place.

■ About the power supply

Before installing and connecting the Smart Sensor, be sure to turn it OFF.

Also read “Precautions for Safe Use” and “Precautions for Correct Use” at the beginning of this manual, and check the power supply and wiring.

Amplifier Unit

This section describes installation of Amplifier Unit, and connection of the I/O cable.



CHECK! ON.

Before connecting/disconnecting peripheral devices, make sure that the Smart Sensor is turned OFF. The Smart Sensor may break down if the Sensor Head is connected or disconnected while the power is

Installing the Amplifier Unit

■ Installing on the DIN track

Amplifier Units can be easily mounted on the 35 mm DIN track.

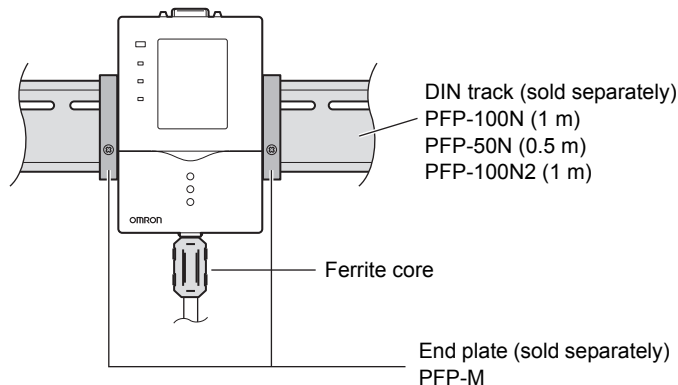

CHECK!

Attach the ferrite core (provided with the Smart Sensor) to the I/O cable of the Amplifier Unit.

● Installation procedure

1. Hook the connector end of the Amplifier Unit onto the DIN track.

2. Push the Amplifier Unit down onto the DIN track until the hook on the I/O cable side is locked.

Push down until you hear it snap into place.

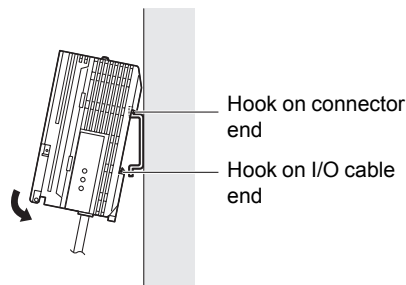

Always hook the connector end of the Amplifier Unit on the DIN track first. Hooking the I/O cable end on the DIN track first may impair the mounting strength of the DIN track attachment.

● Removal procedure

The following describes how to remove the Amplifier Unit from the DIN track.

1. Pull the hook on the I/O cable end of the Amplifier Unit downwards.

2. Lift up the Amplifier Unit from the I/O cable end, and remove it from the DIN track.

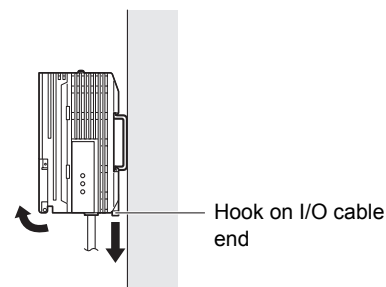

■ Mounting on a panel

The Panel Mount Adapters (sold separately ZS-XPM1) can be used to mount the Amplifier Unit on a panel.

 Panel Mount Adapters p.128

- 1. Push out the Amplifier Unit from the rear of the panel towards the front.**

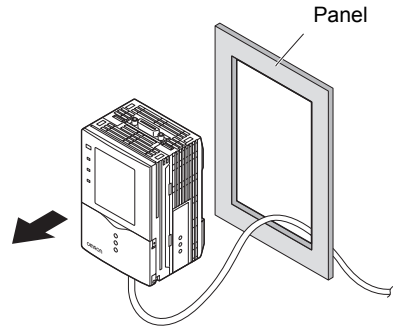

- 2. Install the short Panel Mount Adapters on the four holes on the Amplifier Unit.**

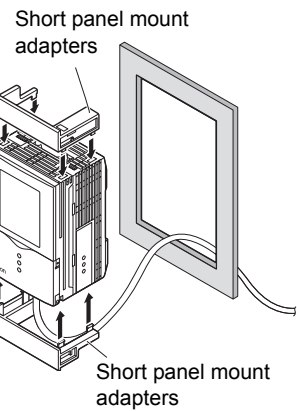

- 3. Install the long Panel Mount Adapters on the two holes on the short Panel Mount Adapter.**

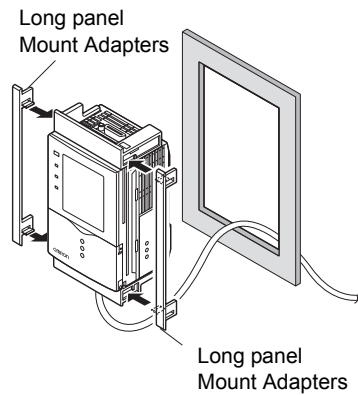

4. Install the Amplifier Unit with Mount Adapters attached onto the panel from the front.



Take care not to pinch the I/O cable.

CHECK!

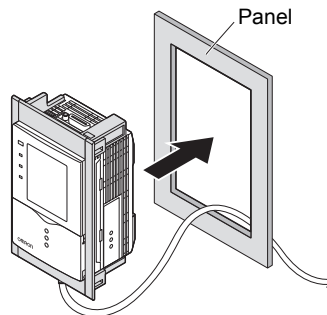

5. Hook the hooks of the mounting bracket onto the two holes of the smaller Mount Adapters and tighten the screws.

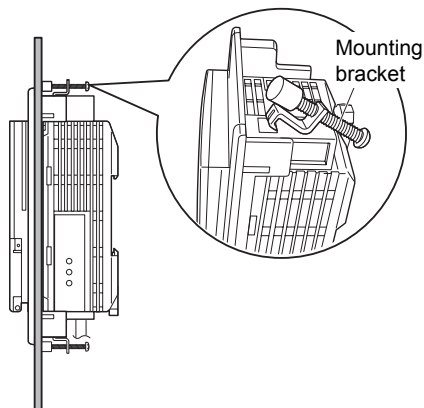

6. Make sure that the Amplifier Unit are firmly fixed on the panel.

Gang-Mounting

The following describes how to gang-mount Amplifier Units.

■ Mounting on a DIN track

1. Install a Amplifier Unit on a DIN track.

 p.33

2. Open the connector cover of each Amplifier Unit.

Slide the cover to remove.

3. Insert the Controller Link Unit into the connector on the one of Amplifier Units.

4. Slide the other Amplifier Unit, and insert into the connector on the Controller Link Unit.

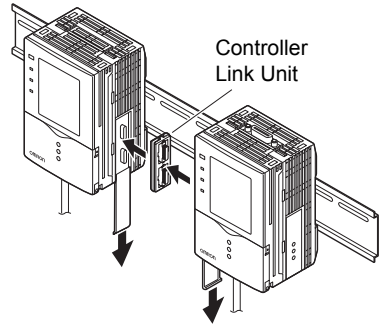

■ Removal procedure

1. Slide one of Amplifier Units, and remove it from the connector on the Controller Link Unit.

2. Slide the Controller Link Unit and remove it from the connector on the Amplifier Unit.

3. Put the cover on the connector of the Amplifier Unit.

4. Pull the hook on the I/O cable end downwards.

5. Lift up the Amplifier Unit from the I/O cable end, and remove it from the DIN track.

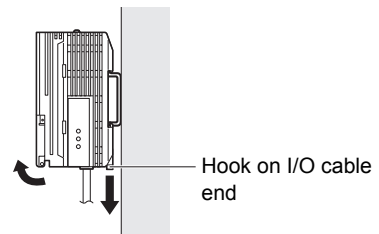
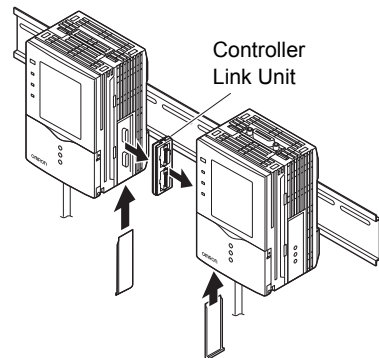

● **Mounting on a panel**

The Panel Mount Adapters (sold separately ZS-XPM1/XPM2) can be used to mount the Amplifier Unit on a panel.

 Panel Mount Adapters p.128

1. Install a Amplifier Unit on a DIN track.

 p.33



When mounting on a panel, be sure to install the DIN track on the rear side of the Amplifier Unit for support.

CHECK!

2. Push out the Amplifier Unit from the rear of the panel towards the front.

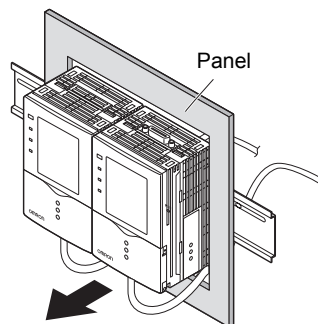

3. Install the small Mount Adapters on the four holes on the Amplifier Unit.



Panel Mount Adapter Install the small Mount Adapters on all gang-mounted Amplifier Units.

CHECK!

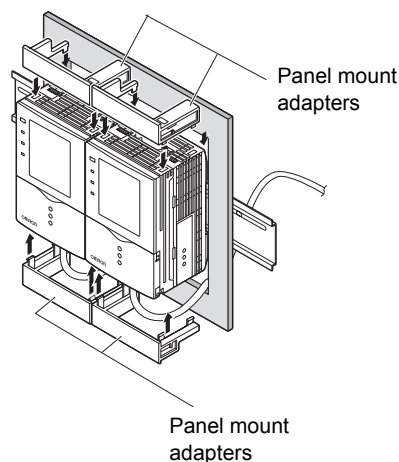

4. Install the long Mount Adapters on the two holes on the small Mount Adapter.



Install the long Mount Adapters only on both sides of gang-mounted Amplifier Units.

CHECK!

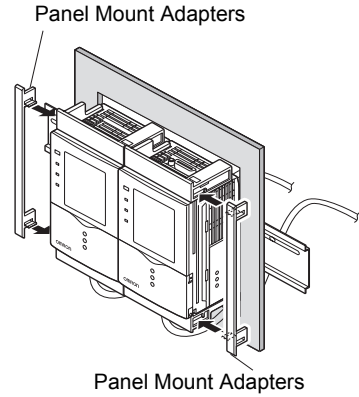

5. Install the Amplifier Unit with Mount Adapters attached onto the panel from the front.



Take care not to pinch the I/O cable.

CHECK!

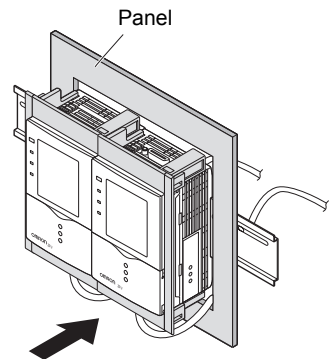

6. Hook the hooks of the mounting fixture onto the two holes of the smaller Mount Adapters and tighten the screws.



Attach two mounting fixtures each on all gang-mounted Amplifier Units.

CHECK!

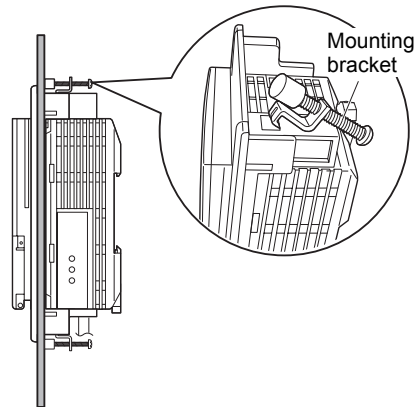

7. Make sure that the Amplifier Unit are firmly fixed on the panel.

About the I/O Cable

The following shows the leads that comprise the I/O cable.

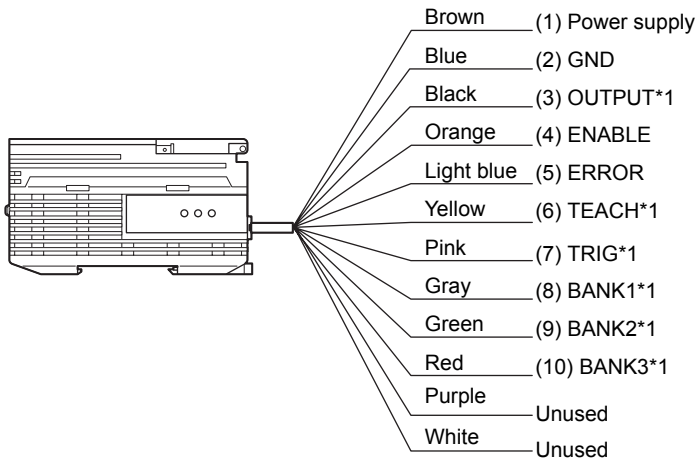

*1: Enabled only in the RUN mode

(1) Power Supply

This connects the power supply.

Use a DC power supply with safe extra-low-voltage circuits to prevent high voltage.

 Recommended power supply unit p.21

Wire the power supply separately from other devices. Wiring them together or placing them in the same duct may cause induction, resulting in malfunction or damage.

(2) GND

The GND terminal is the 0 V power supply terminal.

(3) OUTPUT (control output)

This outputs judgment results. This lead is interlocked with OUTPUT LED.

(4) ENABLE (enable output)

This turns ON when the sensor is ready for measurement.

(5) ERROR (error output)

This turns ON when an error is generated. This lead is interlocked with ERR LED.

 Error Messages and Corrective Actions p.119

(6) TEACH (teaching input)

There are two teaching modes, workpiece stop teaching and workpiece move teaching. These teaching modes can be selected in the menu.

 Selecting the Teaching Mode from an External Device p.97

(7) TRIG (measurement trigger input)

There are two measurement modes, synchronous measurement and continuous measurement. Which mode of measurement is to be performed in is selected in the menu.

 Selecting the Measurement Timing p.97

(8) BANK1 (bank switching input 1)

(9) BANK2 (bank switching input 2)

(10) BANK3 (bank switching input 3)

The bank No. can be switched when BANK1 to BANK3 are connected as follows.

Bank No.	BANK1	BANK2	BANK3
BANK1	OFF	OFF	OFF
BANK2	ON	OFF	OFF
BANK3	OFF	ON	OFF
BANK4	ON	ON	OFF
BANK5	OFF	OFF	ON
BANK6	ON	OFF	ON
BANK7	OFF	ON	ON
BANK8	ON	ON	ON

 Timing Charts p.42

■ I/O Circuit diagrams

● NPN output type (ZFV-CA40)

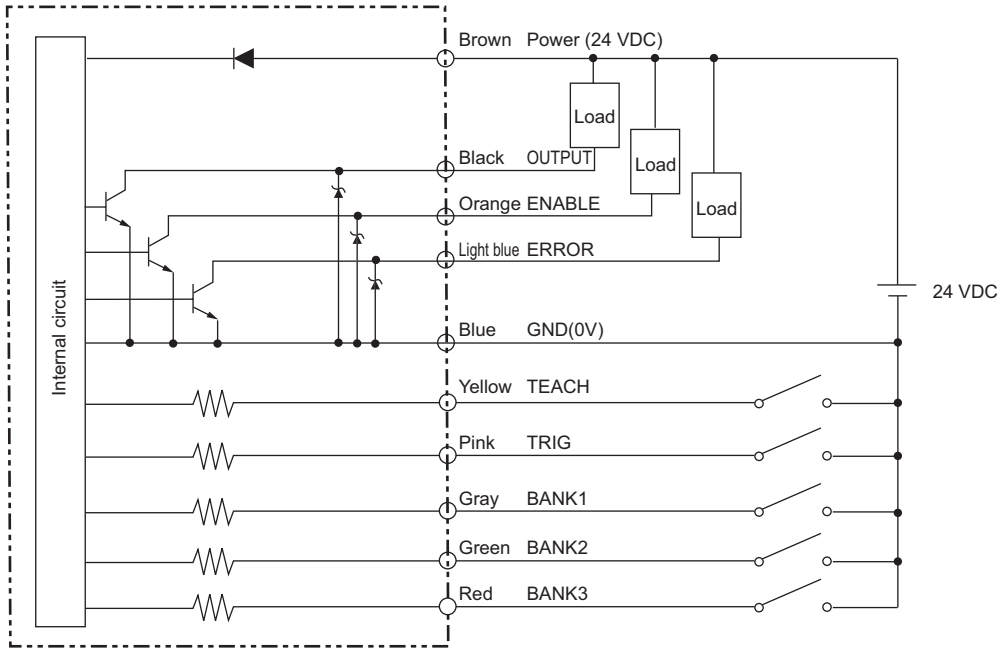

● PNP output type (ZFV-CA45)

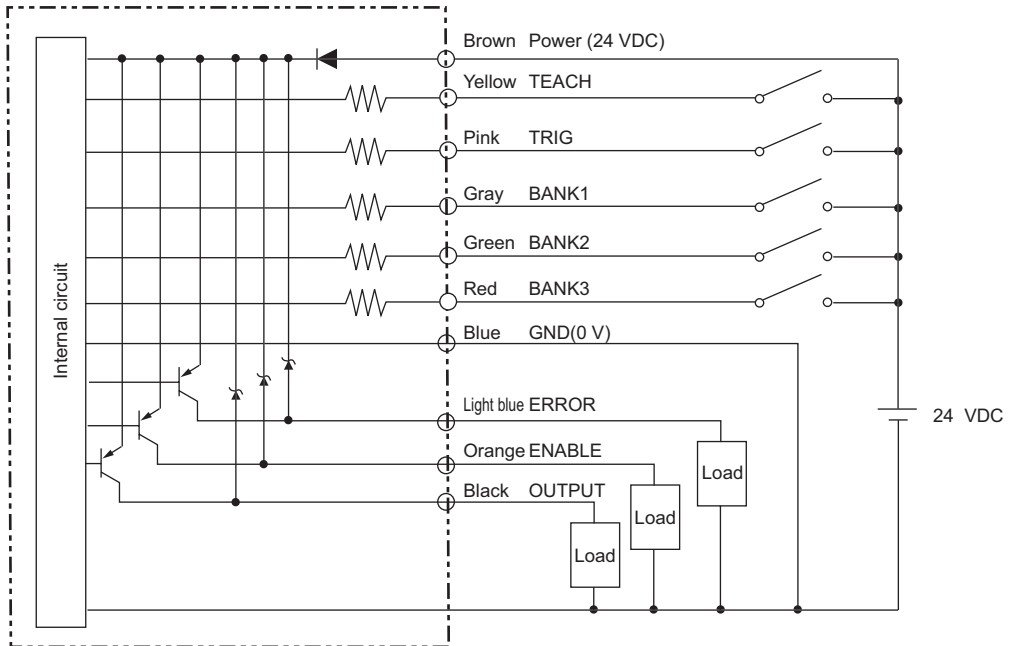

Timing Charts

The following shows the timing charts when communication is performed with external devices.

■ Measurement

● Continuous measurement

Measurement is performed continuously for the duration that the TRIG signal is ON. The measurement result is updated, and output to external devices at each measurement cycle.

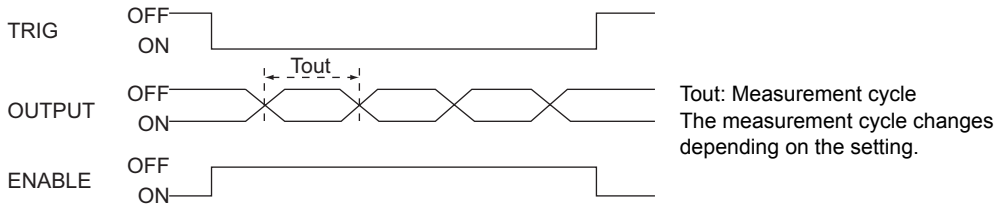

● Synchronous measurement

Measurement is performed only once in synchronous with the change in TRIG signal state from OFF to ON, and the result is output.

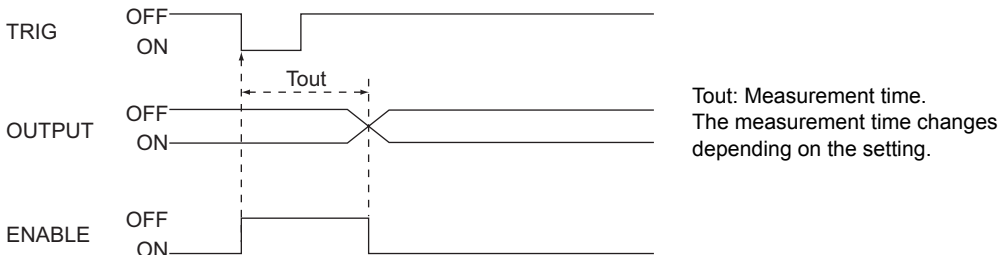

- The minimum ON time width of the TRIG signal is 1 ms.
- The OUTPUT signal is held until the measurement result is updated.
Note, however, when one-shot output is set, the OUTPUT signal is held for the preset time.

 One-shot Output p.107

■ Teaching

● Workpiece stop teaching

Teaching processing is performed according to TRIG signal input after the TEACH signal is input.

Measurement is not performed while teaching is being performed. Do not move the workpiece until teaching is completed.

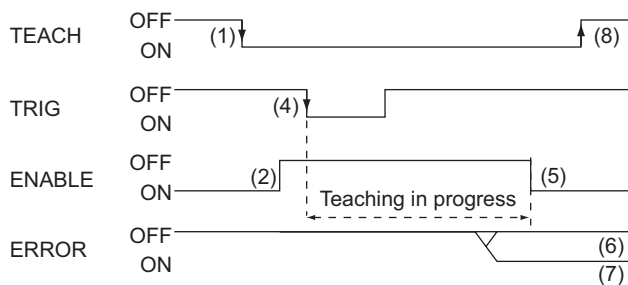

- (1) Turn the TEACH signal ON.
- (2) Confirm that the ENABLE signal has turned OFF.
- (3) Make sure that the workpiece to be taught is in the teaching area.
- (4) Input the TRIG signal.
- (5) The ENABLE signal turns ON after teaching is completed. At this timing, check the state of the ERROR signal.
- (6) When teaching has been completed successfully, the ERROR signal stays OFF.
- (7) When teaching fails, the ERROR signal turns ON.
- (8) Turn the TEACH signal OFF, and end teaching processing.
When teaching fails, the state before teaching was initiated is returned. Perform teaching again.
If the TEACH signal is turned OFF midway, teaching is disabled.

● **Workpiece move teaching**

Use this teaching mode when the object cannot be stopped. Teaching processing is divided up and performed in synchronous with the TRIG signal input after the TEACH signal is input.

Teaching must be processed eight times. Measurement is not performed while teaching is being performed.

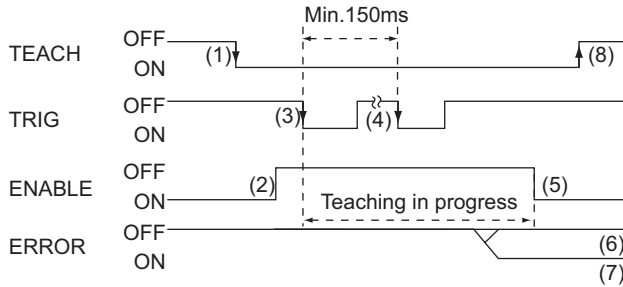

- (1) Turn the TEACH signal ON from the outside.
 - (2) Confirm that the ENABLE signal has turned OFF.
 - (3) Input the TRIG signal at the timing for measuring the workpiece to be taught.
 - (4) Repeat the input in step (3) eight times. (Trigger inputs from the ninth time onwards are ignored.)
 - (5) The ENABLE signal turns ON after teaching is completed. Check the state of the ERROR signal at this timing.
 - (6) When teaching has been completed successfully, the ERROR signal stays OFF.
 - (7) When teaching fails, the ERROR signal turns ON.
 - (8) Turn the TEACH signal OFF, and end teaching processing.
- When teaching fails, the state before teaching was initiated is returned to. Perform teaching again.
- If the TEACH signal is turned OFF midway, teaching is disabled.

Sensor Head

This section describes how to install and connect the Sensor Head.

Affixing LED Warning Labels

Affix warning labels (supplied with the sensor) to appropriate positions (e.g. cable) near the sensor. (ZFV-SC50/SC50W/SC90/SC90W only)

- Label affixing example

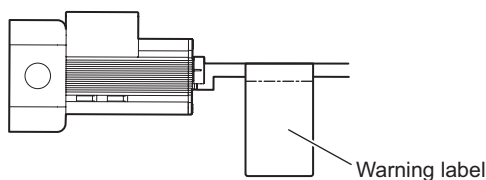

Warning label

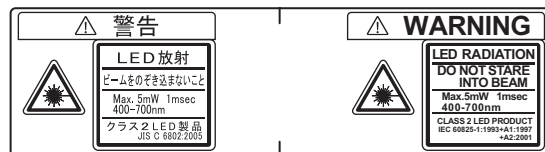

Installing the Mounting Fixture

Attach the mounting fixture (provided with the Smart Sensor) to the side of the Sensor Head.



CHECK!

No mounting bracket is needed for the ZFV-SC150/SC150W sensor heads since it is integrated.

■ Installation procedure

The mounting fixture can be installed on all of the four mounting surfaces.

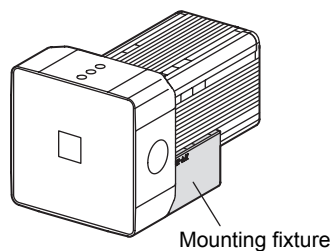

1. Align the two hooks on one side of the mounting fixture with the two grooves on the Sensor Head body (light emitting side).

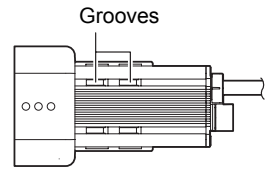

2. Push the other hook.
Push down until you hear it snap into place.

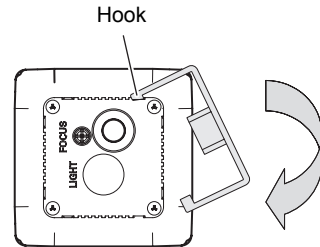

3. Make sure that the mounting fixture is firmly fixed on the Sensor Head.

■ Removing a mounting fixture

Insert a screwdriver into the gap (one of the two gaps) between the mounting fixture and the Sensor Head case, and remove the mounting fixture.

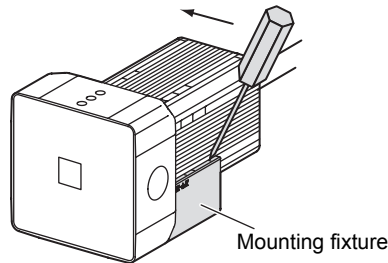

Installing the Sensor Head

This section describes how to install the Sensor Head.

■ Setting distance

The following graphs show the relationship between detection range and setting distance for each model of Sensor Head.

Values differ according to each model of Sensor Head, so check the model before using these graphs.

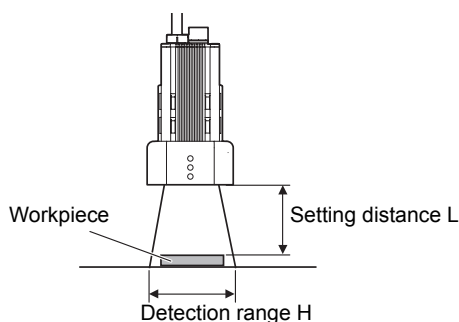

• ZFV-SC10

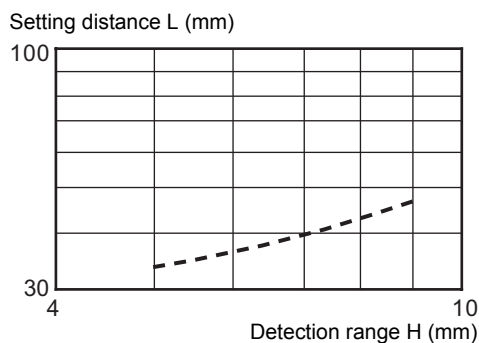

Detection range H (mm)	Setting distance L (mm)
5	34
6	37
7	40
8	44
9	49

• ZFV-SC50

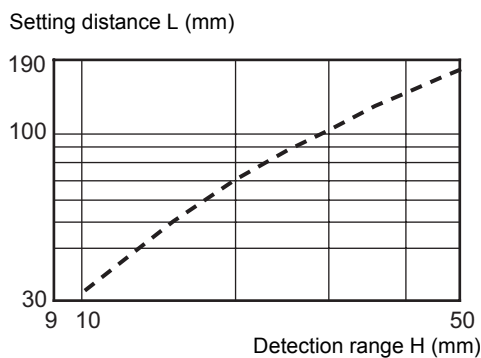

Detection range H (mm)	Setting distance L (mm)
10	31
15	51
20	70
25	90
30	109
35	128
40	148
45	167
50	187

• ZFV-SC90

Setting distance L (mm)

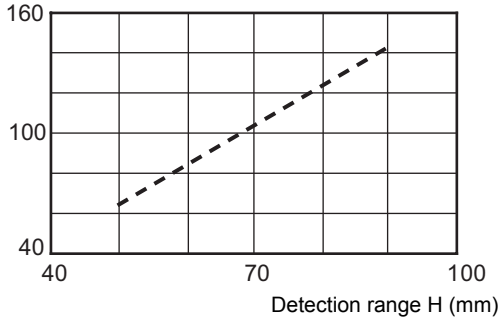

Detection range H (mm)	Setting distance L (mm)
50	67
55	76
60	86
65	95
70	104
75	114
80	123
85	132
90	142

• ZFV-SC150

Setting distance L (mm)

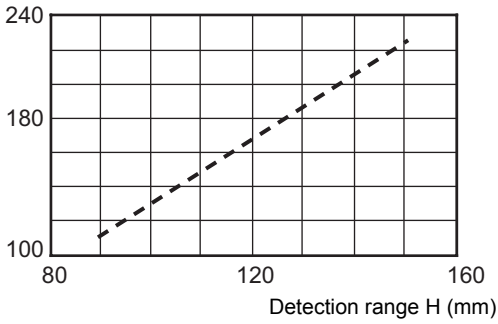

Detection range H (mm)	Setting distance L (mm)
90	115
95	124
100	134
105	143
110	152
115	162
120	171
125	180
130	190
135	199
140	208
145	218
150	227

■ Adjusting the Sensor Head Focus

1. Set the menu selector switch to “STD menu” and the mode selector switch to “MENU mode”.



2. Set the reference workpiece in place.

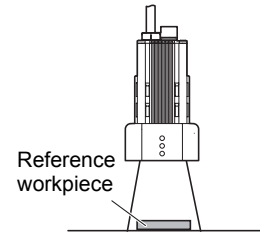

3. Place the cursor on  and press the SET Key.



4. Adjust the camera's setting distance.
Refer to the graph and set the camera in a position so that the area to be checked is within the detection area (LCD monitor).

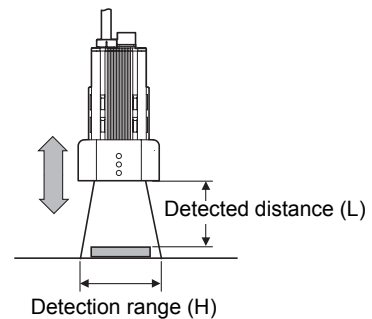

5. Turn the focus adjustment control to the left and right to adjust the focus.

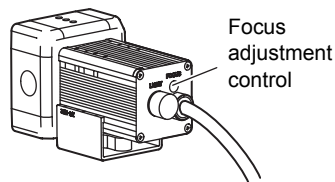

For ZFV-SC10/SC50/SC50W

- Turn to right: Focuses to the far side.
- Turn to left: Focuses to the near side.

Default is focus set at furthest point.



CHECK!

First turn the focus adjustment control slightly to the left and right, to make sure that the Focus adjustment control is not at the upper or lower limit positions. The focus adjustment control is a multi-turn potentiometer. However, the control stops turning at the upper or lower limit positions. Do not exert unnecessary force to turn the control at the upper or lower limit positions as this might damage the control.

For ZFV-SC90/SC90W/SC150/SC150W

- Turn to right: Focuses to the near side.
- Turn to left: Focuses to the far side.

Default is focus set at nearest point.



CHECK!

The focus adjustment control is a multi-turn potentiometer. However, the control stops turning at the nearest position. Do not exert unnecessary force to turn the control as this might damage the control. It turns free at the farthest position.

If the workpiece is glossy, install the Sensor Head at an angle to prevent mirror reflection light from being picked up by the sensor.

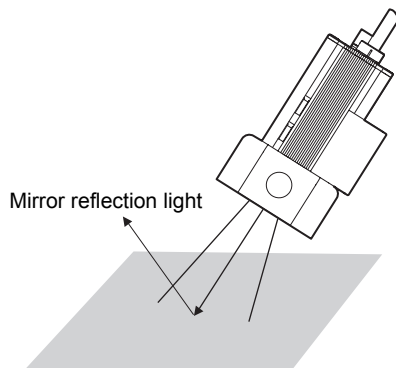

6. Check the image.

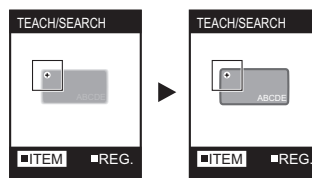

Connecting the Sensor Head

This section describes how to connect the Amplifier Unit.



CHECK!

- Before connecting/disconnecting the Sensor Head, make sure that the Amplifier Unit is turned OFF. The Smart Sensor may break down if the Sensor Head is connected or disconnected while the power is ON.
- Do not touch the terminals inside the connector.

■ Connecting the Sensor Head

Insert the Sensor Head connector into the Sensor Head connector of the Amplifier Unit.

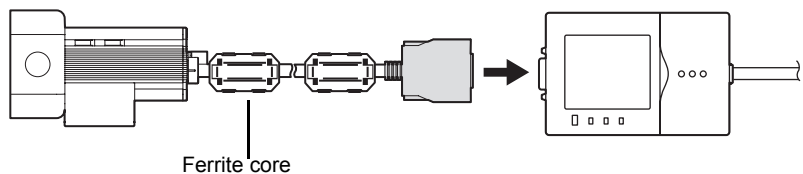

CHECK!

- Attach the ferrite cores on the cable of the Sensor Head. Make sure that one ferrite core is attached to the connector side as well as to the body side.

■ Disconnecting the Sensor Head

Pull out the Sensor Head connector while pressing the hooks on both sides of the Sensor Head connector.

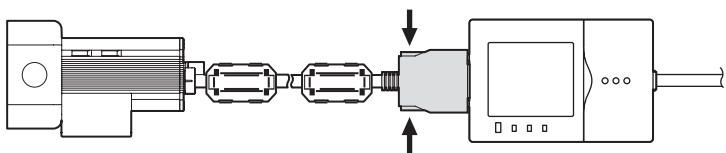

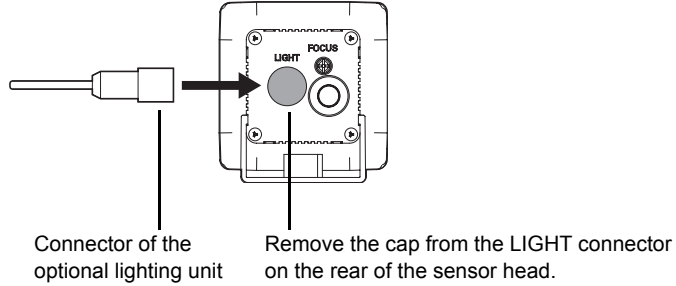

■ Connecting the Optional Lighting Unit

This optional lighting unit can be mounted to the rear connector of the sensor head (ZFV-SC50/SC50W/SC90/SC90W) with a single motion, and no power supply is required for the unit.



Section 3

FUNCTIONS AND OPERATIONS TO BE USED

 Switching the Display Content	54
 Key Operations for RUN Mode	57
 Switching to Another Bank	58

Switching the Display Content

Display contents on the LCD monitor can be changed in the RUN mode. Content is switched in the following order each time the TEACH/VIEW key is pressed. Display the measured values suitable for your application.



The measurement time differs according to the type of display image. The measurement time for “only image display” is the fastest. The number in parentheses () serves as a guideline when “only image display” is taken as the reference.

When the image is switched during measurement, the measurement time changes. For this reason, monitor the ENABLE signal, wait for the ENABLE signal to turn ON, and then input the TRIG signal.

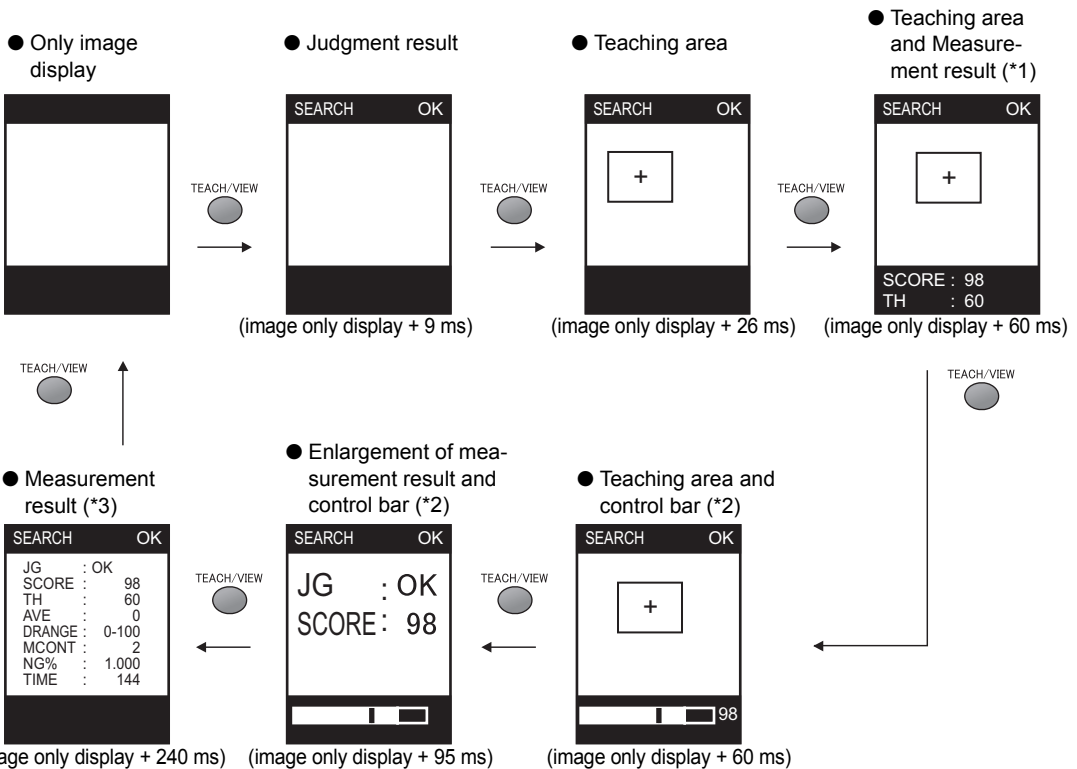

(*1) In the case of [BRIGHT], the display can be switched (average density value, density distribution value) by the LEFT/RIGHT keys.

(*2) The control bar shows the measurement result and judgment threshold value.

(*3) The measurement time (TIME) indicated here is the shortest measurement time in “only image display”.



In the displays showing an image, the image type (color/monochrome) is switched each time the [A] function key is pressed.

Characters Displayed on the LCD Monitor and Their Meanings

Characters in parentheses are the characters that are displayed in the enlarged display mode.

■ Items displayed in common at [ITEM]

Display Characters	Details
JG	Judgment result (OK/NG)
TH	Judgment threshold value In the case of the upper/lower limits, XX - YY (lower limit - upper limit) is displayed.
AVE	Average value of measurement result
DRANGE	Min. and max. of measurement result XX - YY (min. value - max. value)
MCONT	Measurement count (1 to 9999999)
NG%	NG occurrence ratio (NG count/measurement count)
TIME	Measurement time The shortest measurement time when the display image is set to "Display only image".

■ Items displayed individually

● SEARCH, MATCH, CHARA2

Display Characters	Details
SCORE	Correlation values of measured model If [COL JUGE] is set to [ON] in the CUSTOM menu in the case of [SEARCH] and [MATCH], the correlation value will be "0" when the measured area is NG.

● AREA

Display Characters	Details
AREA	Area value (value obtained by normalizing with area value taken during teaching as 100)

● HUE

Display Characters	Details
DIFF	Difference between reference color and measured color  Hue Indication Number p.159

● WIDTH

Display Characters	Details
WIDTH	Edge width

● **POSITION**

Display Characters	Details
GAP	Deviation from reference position

● **COUNT**

Display Characters	Details
CNT	Count number

● **BRIGHT**





Display Characters	Details
DENAVE	Density average value
DENDEV	Density distribution value

● **CHARA1**

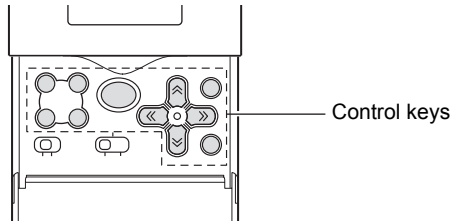
Display Characters	Details
DENDEV	Density distribution value

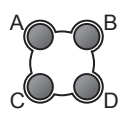
Key Operations for RUN Mode



Key		Description
TEACH/VIEW key		Switches the display content.
Function keys		A: Switches the image display conditions. B: (Not used) C: Performs measurement again. D: (Not used)
← LEFT key → RIGHT key		In [BRIGHT], the display content is switched between "average density value" and "density distribution value".
↑UP key ↓ DOWN key		Not used.
SET key		Not used.
ESC key		Not used.

Switching to Another Bank

ZFV-C can hold up to eight sets of settings. These settings can be switched externally according as inspection condition. A set of these settings is called a “bank”. A bank also contains the threshold value set in ADJ mode.

- What is a Bank?

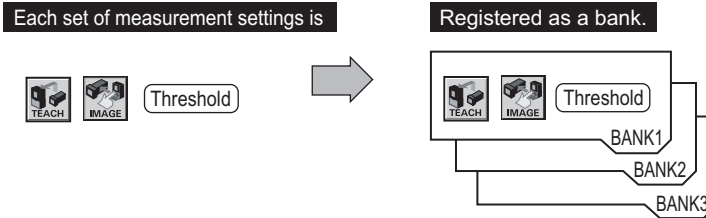

Switching to another bank by control keys

1. Switch to MENU mode.

2. Select  .

3. Select the desired bank number.

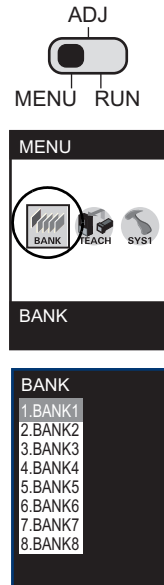

Switching to another bank by the external signal

A bank can be switched from one to another by combining BANK input signals 1 to 3. This is possible with RUN mode only.

 Wiring p.39

The setting for the bank switching method must be changed.

 Setting the Bank Switching Method p.95



Bank switching is also possible by CompoWay/F or by entering a non-procedural command.

Section 4

SETTING OF INSPECTION CONDITION

☒ Basic Knowledge for Operation	60
Displays of MENU/ADJ Mode and Key Operations	60
Teaching Flow	61
☒ Inspecting by Pattern (PATTERN)	62
☒ Inspecting by the Size (Area)	66
☒ Inspecting by Color (HUE)	70
☒ Inspecting by Width (WIDTH)	72
☒ Inspecting by Position (POSITION)	75
☒ Inspecting by Count (COUNT)	78
☒ Inspecting by Brightness (BRIGHT)	81
☒ Detecting Presence of Character String (CHARA)	84

Basic Knowledge for Operation

Displays of MENU/ADJ Mode and Key Operations

Make setups by the control keys while looking at the menus and the image displayed on the LCD monitor.

The details that are displayed differ according to the operating mode.

• MENU mode

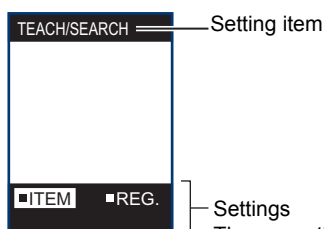

Setting item

Settings

The currently selected item is displayed with black in white background

• ADJ mode

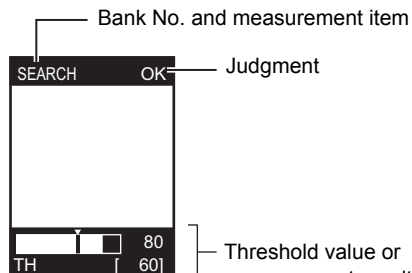

Bank No. and measurement item

Judgment

Threshold value or measurement result

Key operation

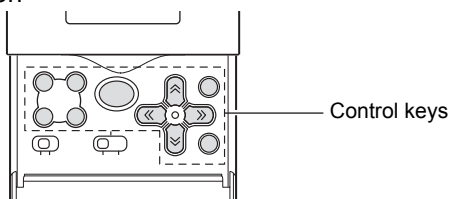

Key		Description
← LEFT key → RIGHT key		The function of these keys differs according to the operating mode. In MENU mode: Moves through menus. In ADJ mode: Changes the adjustment item (type of threshold value).
↑UP key ↓ DOWN key		The function of these keys differs according to the operating mode. In MENU mode: Moves between menus, selects parameters, and sets numerical values. In ADJ mode: Changes numerical values.
TEACH/VIEW key	TEACH/VIEW 	The function of these keys differs according to the operating mode. In MENU mode: Executes teaching. In ADJ mode: Switches the screen display.
SET key	SET 	<ul style="list-style-type: none"> • Selects menus • Selects items
ESC key	ESC 	Returns to the previous menu.
Function keys		A: Switches the image display conditions. (effective in the displays showing an image) B: (Not used) C: (Not used) D: Sets the detailed color selection conditions (effective in the color pickup screen).

Teaching Flow

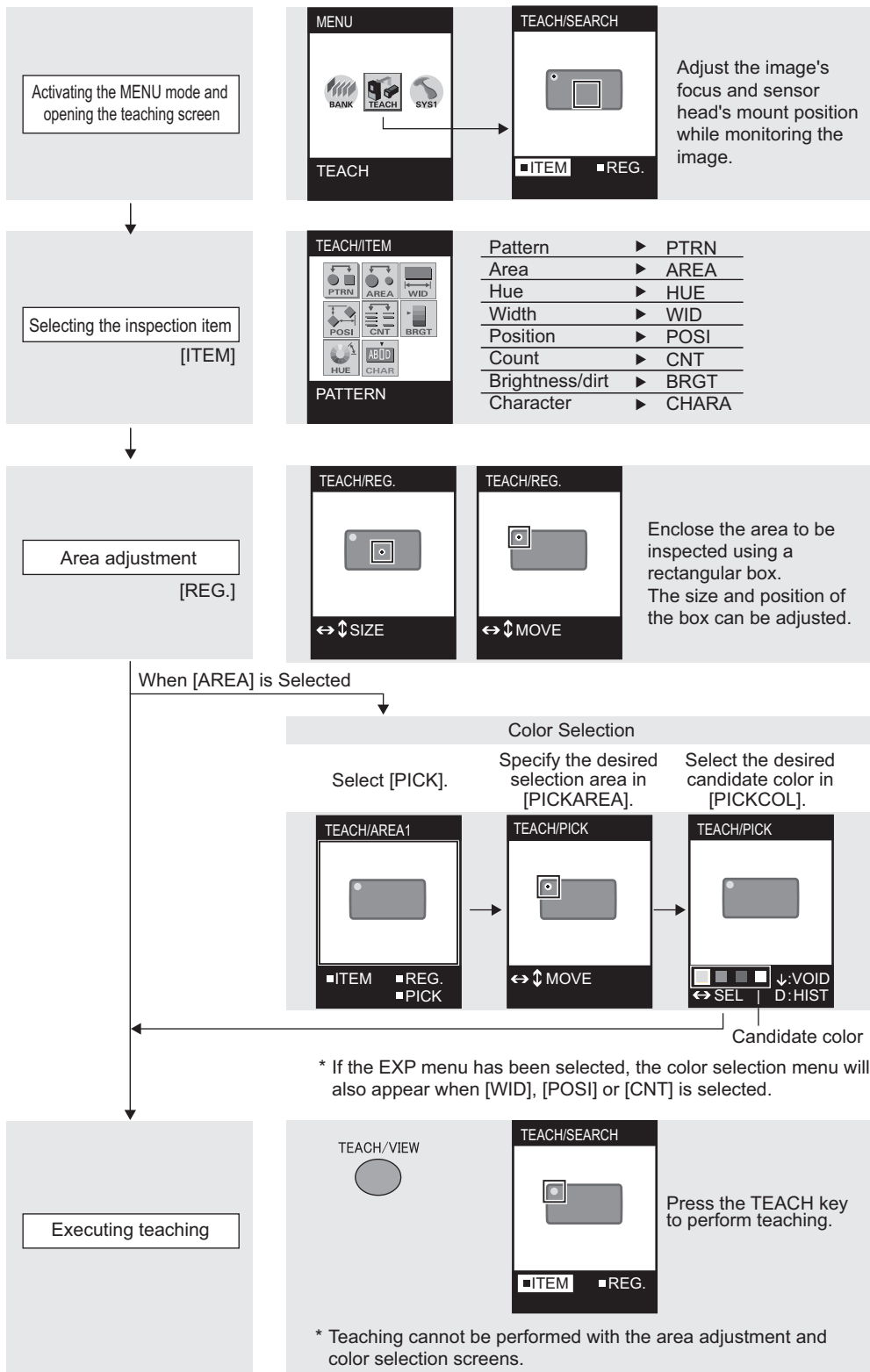

Inspecting by Pattern (PATTERN)

Inspects “presence/absence” of the workpiece and judges whether the type of workpiece is correct.



There are two measurement items for [PATTERN]: [SEARCH] and [MATCH].

● Search

Judgment is performed by whether the registered model is or is not in the inspected area. This item works with workpieces tilted to an angle of $\pm 45^\circ$.

Example: Inspection of upside down orientation, and color of electronic components

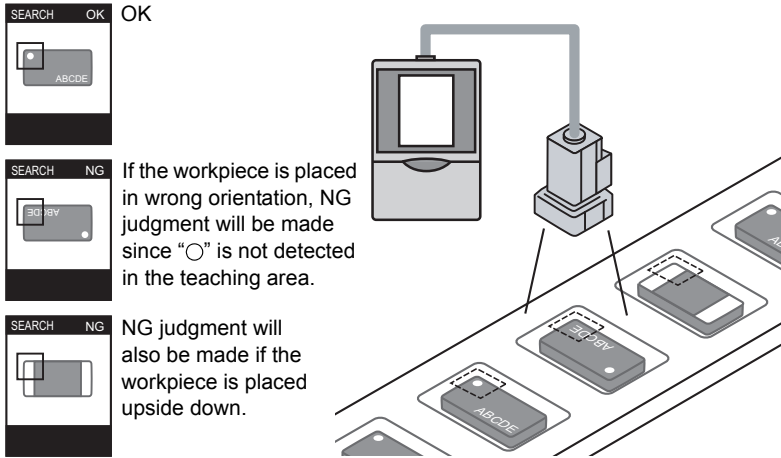

● Match

Select this item for inspecting shapes and recognizing different objects. Judgment is performed by comparing the degree of match between a registered model and the target workpiece. Compared with [SEARCH], more detailed inspection is possible, and larger workpieces can be inspected. Note, however, that this item does not work with tilted workpieces.

Example: Inspection of wrong model and color of electronic components

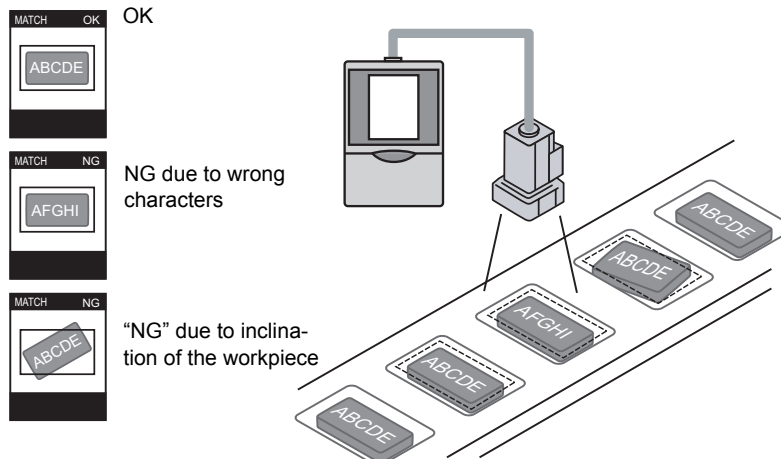

Basic Setting Procedure

Teaching

The area to be inspected needs to be enclosed by a rectangular box, then teach it. The selected image in the area is registered as the inspection reference (model). Measurement is unstable when there are two or more of the same pattern. Register unique pattern in the screen or restrict the search range.

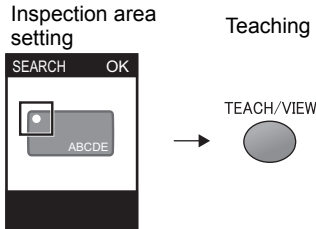

Application and Setting Examples p.150

Adjusting the threshold level

Threshold values are adjusted to determine the range for OK judgment. Adjust the threshold values referring to the current indicated measurement results. Adjustment of the threshold values must be done in ADJ mode.

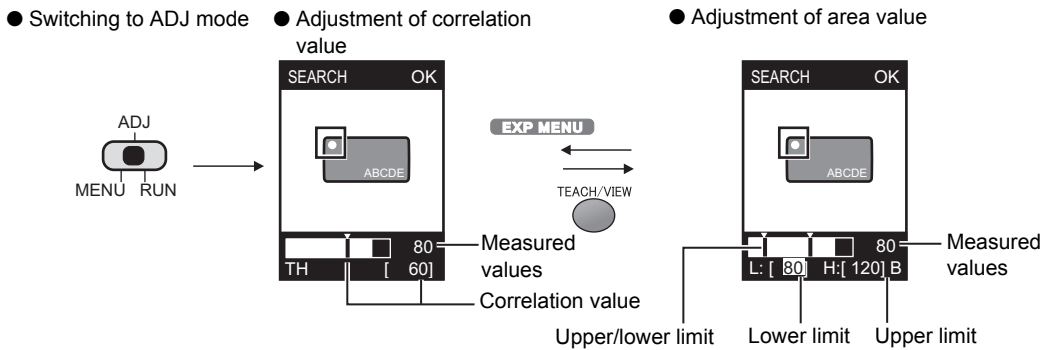

LEFT/RIGHT keys: Select upper limit/lower limit.
UP/DOWN keys: Change values.

Setting item	Range	Details of Adjustment
Correlation value	0 to 100	This is the lower limit of the correlation value with the teaching model. This value or above is judged as OK.
Area value	0 to 999	Displayed when [COL JUGE] - [ON] is selected in the CUSTOM menu. "Area of the largest color group" is registered as the reference area when teaching is performed. Set the range for OK judgment with the registered area as "100".

CUSTOM Menu EXP MENU

Items that can be customized

Items that can be customized		Page
Items Related to pattern	Changing the search area	p.64
	Setting the rotation range of a workpiece (only when [SEARCH] is selected)	p.64
Items related to color	Changing the filter color	p.65
	Performing color check	p.65
	Teaching brightness	p.65

■ Items related to pattern

● Changing the search area

Change the area to search the model in. Specify the top left and bottom right of the search area.

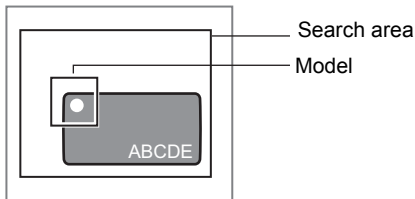

▶ MENU mode-[TEACH] -[CUSTM] -[SEARCH AREA]

● Setting the rotation range of a workpiece (only when [SEARCH] is selected)

Set this item when even a tilted workpiece is to be set as a non-defective item.

▶ MENU mode-[TEACH]-[CUSTM]-[ROTATION]

Setting	Details
±10° (default), ±20°, ±30°, ±45°	Set the range of acceptable tilt. The wider the rotation range, the longer the measurement time.

■ Items related to color

● Changing the filter color

By default (AUTO), a color filter that increases the contrast of “area of the largest color group” and “area of the second largest color group” located inside the area will be selected automatically.

If the contrast of the desired image is not increased with [AUTO], the filter color can be changed to suit the image.

▶ MENU mode-[TEACH]-[CUSTM]-[FILTER]

Setting	Details
AUTO (default)	A color filter that increases the contrast of “area of the largest color group” and “area of the second largest color group” located inside the area will be selected automatically.
RED, GREEN, BLUE, YELLOW, CYAN, MAGENTA	Select the color filter that is suitable for the image to be inspected.
MONOCHROME	Disables the color filter to convert the image to a monochrome image.

● Performing color check

For more stable judgment, inspection is performed using color information in addition to pattern information.

▶ MENU mode-[TEACH]-[CUSTM]-[COL JUGE]

Setting	Details
OFF (default)	“Area of color” is not checked. Only “degree of similarity to model shape” is checked.
ON	The area of the color is checked, and the correlation value will be “0” if the result is NG.

● Teaching Brightness

If this function is set to [ON] (default), even if the brightness changes due to fluctuation of surround lighting, the sensor works well, thereby this function is useful to prevent color pickup problems that may occur due to lighting fluctuation.

If this function is set to [OFF], workpieces whose brightness and vividness differ from those of the workpiece that was “taught” first can be identified.

▶ MENU mode-[TEACH]-[CUSTM]-[LIGHT TEACH]

Setting	Details
ON (default)	The brightness/chromaticness range for color selection is changed during teaching.
OFF	The brightness/chromaticness range for color selection is not changed during teaching.

Inspecting by the Size (Area)

Select this item to inspect objects by size (area).

There are two measurement items for [AREA]: [AREA1] and [AREA2].



● AREA1

Make a judgment based on the total area of the picked-up colors (max. 4 colors).

This method is useful when the workpiece is not stationary and it has halation or printed characters.

Example: Inspection of shortages in confectionery

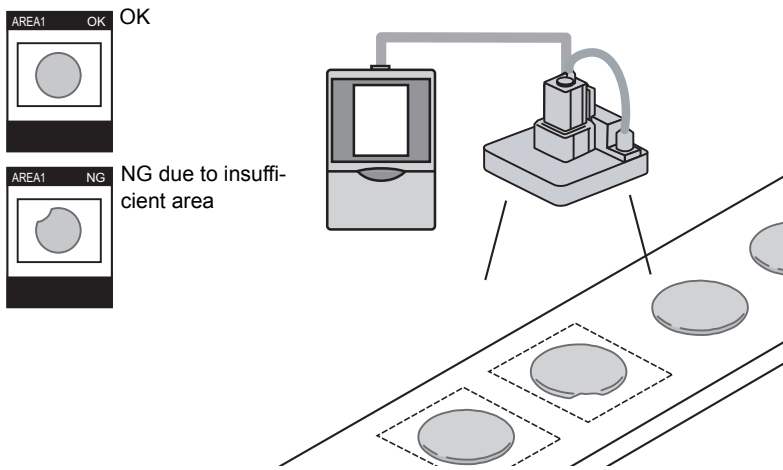

● AREA2

Make a judgment based on the area of each picked-up color (max. 4 colors). The judgment will be "OK" if the area of every color is within the specified threshold. This method is suitable when some colors are missing or the colors are different.

Example: Campaign labels inspection

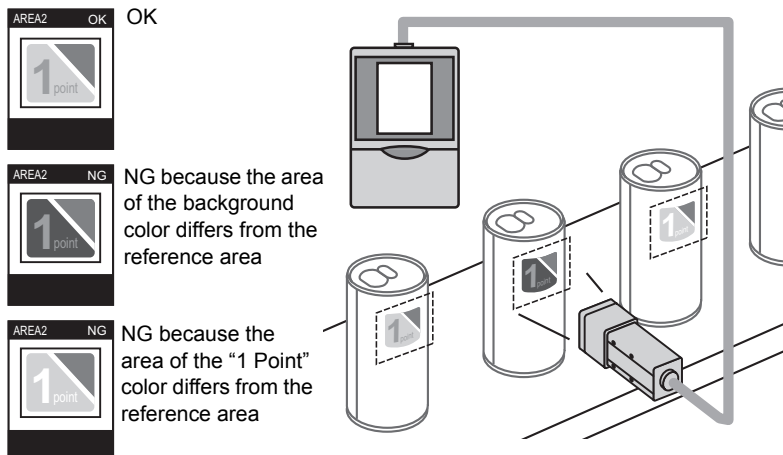

● **AREA3**

Measure the area by specifying the measurement target according to brightness, not color, difference. (Binary image)

This method is suitable when detecting a glossy metal surface and making a presence/absence judgment according to the brightness difference, not to the color difference.

Example: Detection of presence of screw holes

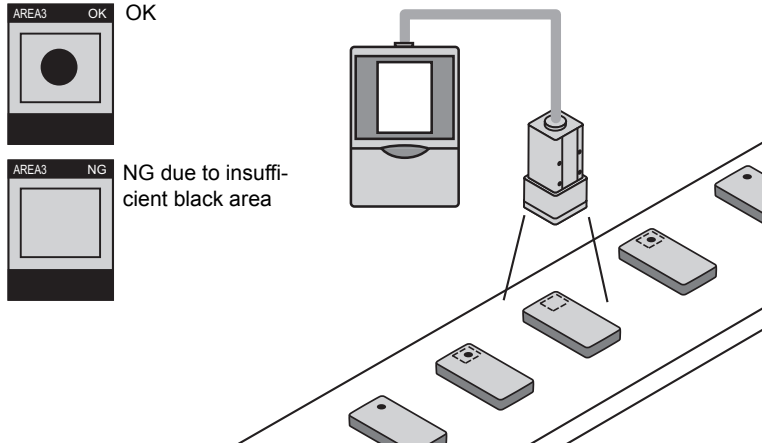

Basic Setting Procedure

Teaching

Teaching is performed after the object and color to be inspected are specified.

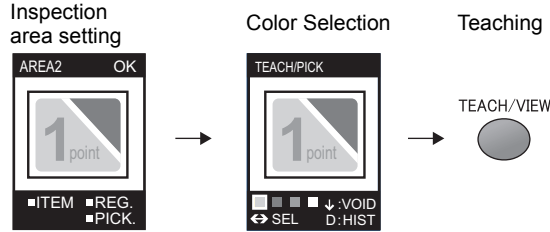

Application and Setting Examples p.152

Adjusting the threshold level

Threshold values are adjusted to determine the range for OK judgments. Adjust the threshold values referring to the currently indicated measurement results. Adjustment of the threshold values must be performed in ADJ mode.

● AREA1/AREA2/AREA3

- Switching to ADJ mode
- Adjusting of area value

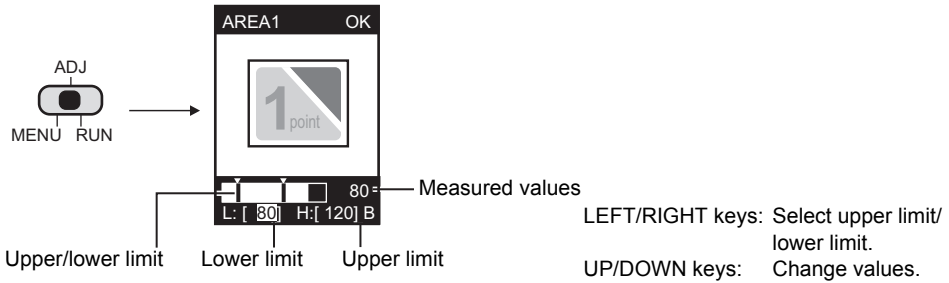

Setting item	Range	Details of Adjustment
Area value	0 to 999	This is the range for OK when the value at teaching is taken to be 100 %. If AREA2 is selected, the same judgment conditions will be used for all the four colors. Judgment is made based on the color, among the four colors, that has the largest difference from the reference value.

CUSTOM Menu EXP MENU

Items that can be customized

	Items that can be customized	Page
Items related to color	Teaching brightness	p.65
Items related to monochrome (When AREA3 is selected)	Selecting the target color	p.69
	Setting binary levels	p.69

■ Items Related to Monochrome

This CUSTOM menu is provided when AREA3 is selected.

● Selecting the target color

Reverse the currently displayed binary image.

As white pixels are targeted for measurement, select which part of the measured area is to be set to white pixels.

▶ MENU mode-[TEACH]-[CUSTM]-[COLOR]

Setting	Details
WHITE (default)	Select which part of the measurement area is to be set as white pixels.
BLACK	

● Setting binary levels

Set the level for converting the color image captured from Sensor Head to a binary image.

▶ MENU mode-[TEACH]-[CUSTM]-[BINARY]

Setting	Details
0 to 255	Adjust the binary level so that the measuring area is the target color.

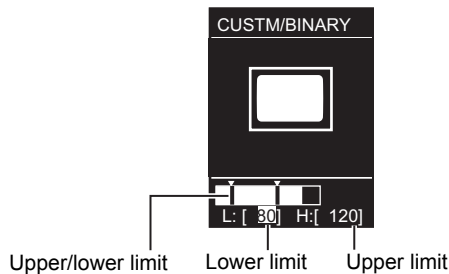

LEFT/RIGHT keys: Select upper limit/lower limit.
UP/DOWN keys: Change values.

Inspecting by Color (HUE)

This item inspects color difference of plain-colored workpieces. If there are two or more colors in the area, the color of the largest area will be the subject of inspection.



Example: Cap color inspection

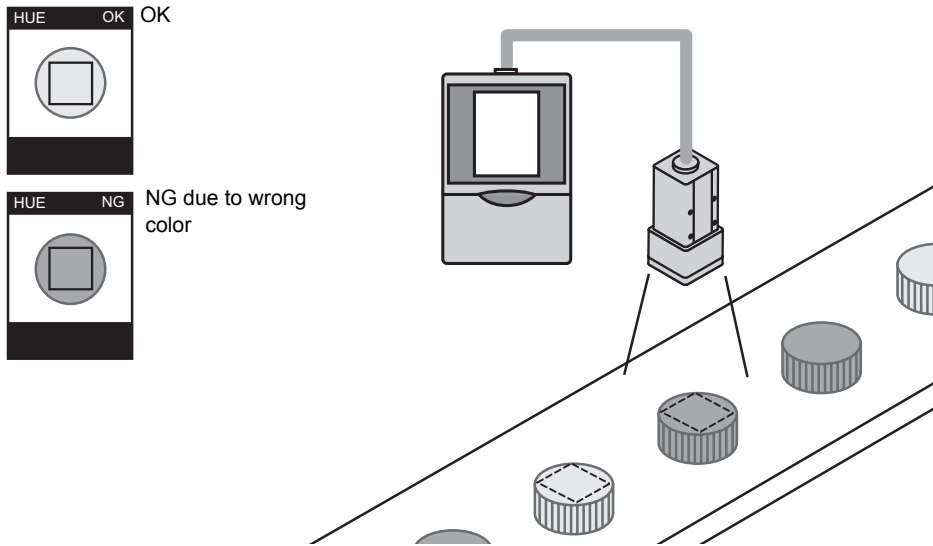

Basic Setting Procedure

■ Teaching

Enclose the area to be inspected using a square box, and then perform teaching.

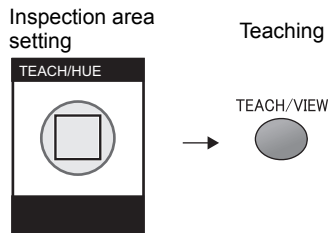

 Application and Setting Examples p.156

■ Adjusting the threshold level

- Switching to ADJ mode

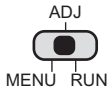

- Adjusting the Threshold Level

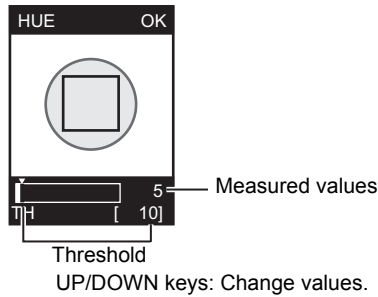

Setting item	Range	Details of Adjustment
Color difference	0 to 509	Threshold for color difference needs to be set. The judgment will be OK if the measured color difference is below the threshold.  Hue Indication Number p.159

Inspecting by Width (WIDTH)

This item inspects the width or gap of workpieces.
It is suitable for applications such as checking lead bend and label position.



Example: Inspection of capacitor lead gap

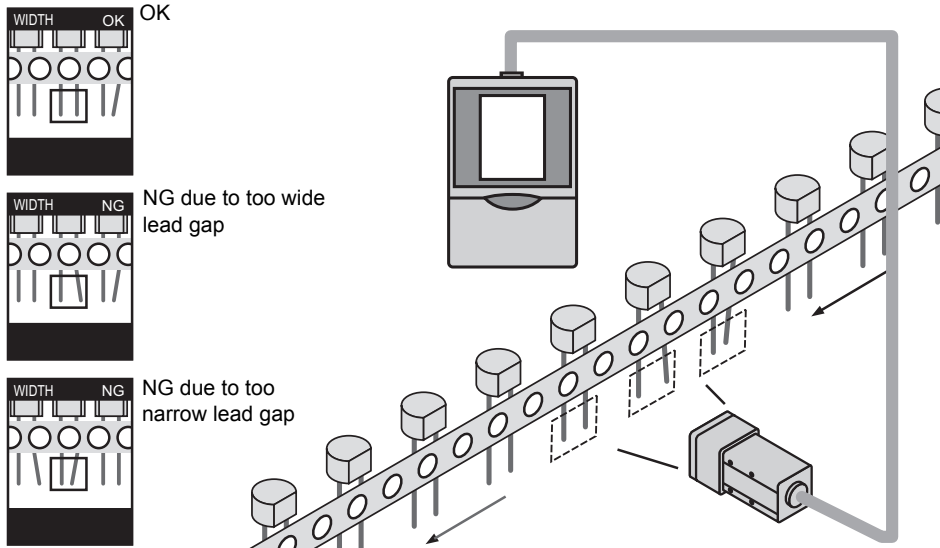

Basic Setting Procedure

■ Teaching

Enclose the area to be inspected using a rectangular box and then perform teaching.

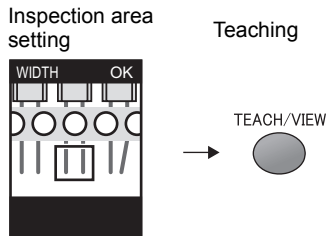

Set so that there are two changes in brightness such as "light to dark" or "dark to light" in the inspection area.

■ Adjusting the threshold level

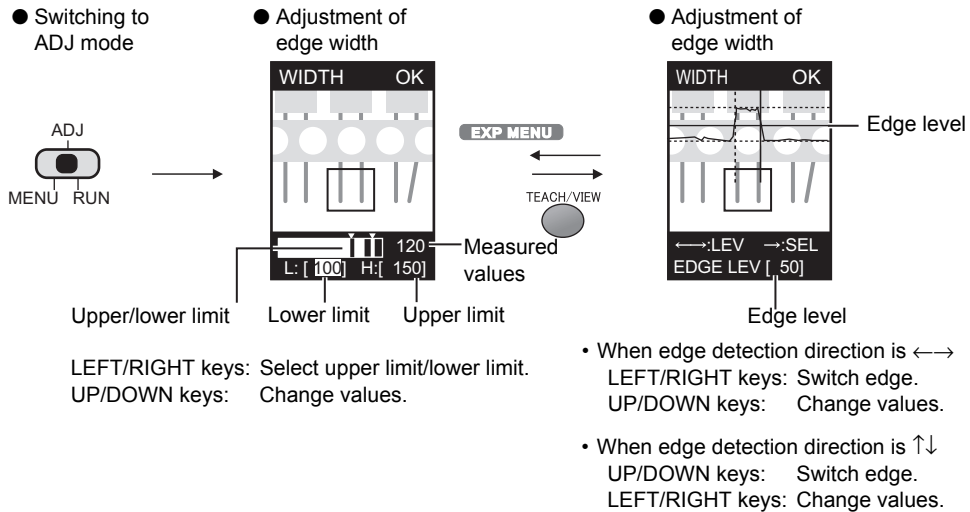

Setting item	Range	Details of Adjustment
Edge width	0 to 999	This is the range for OK when the width at teaching is taken to be 100 %.
Edge level	0 to 100	This is the density level judged to be an edge. Adjust this level when measurement is unstable.

Teaching area —

100% — Max. density value

50% — Edge level

0% — Min. density value

CUSTOM Menu EXP MENU

Items that can be customized

Items that can be customized		Page
Items related to edge detection	Selecting the color of edge	p.74
	Selecting the edge detection direction	p.74
Items related to color	Changing the color mode (default: FILTER)	p.74
	Changing the filter color (only when [FILTER] is selected in [COL MODE])	p.65
	Teaching Brightness (only when [PICKUP] is selected in [COL MODE])	p.65

■ **Items related to edge detection**

Set the direction in which edges are searched and the density level.

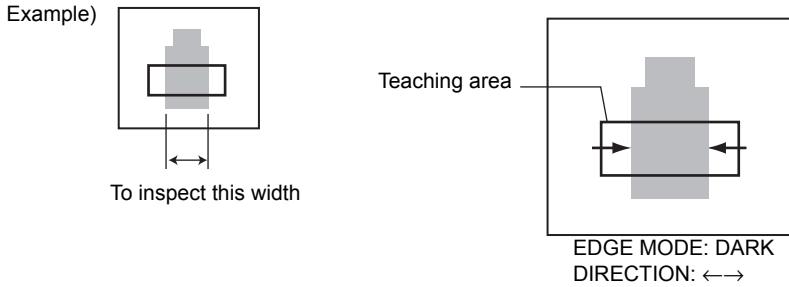

● **Selecting the color of edges**

Select the direction of density change for the edge to be detected.

▶ MENU mode-[TEACH]-[CUSTM]-[EDGE MODE]

Setting	Details
DARK	Dark areas shown in the filtered monochrome image are assumed to be edges.
LIGHT (default)	Light areas shown in the filtered monochrome image are assumed to be edges.

● **Selecting the edge detection direction**

Select the direction in which edges are searched.

▶ MENU mode-[TEACH]-[CUSTM]-[DIRECTION]

Setting	Details
↑ ↓	Searches in the vertical direction.
← → (default)	Searches in the horizontal direction.

■ **Items related to color**

● **Changing the color mode**

ZFV-C has two color inspection modes as follows.

▶ MENU mode-[TEACH]-[CUSTM]-[COL MODE]

Setting	Details
FILTER (default)	A color filter is used to increase the contrast with the background. When [AUTO] filter is selected, a color filter that increases the contrast in the area will be selected automatically. It is also possible to select a filter that suits the workpiece.
PICKUP	Select the color to be checked from a list of colors.

Inspecting by Position (POSITION)

This item is used to check the position of the workpiece. The edge of the workpiece is detected, and judgment is performed by comparing those edge coordinates against reference coordinates. This item is suitable for applications such as checking presence/position of sealing tape and checking label position.



Example: Inspection of label presence/position

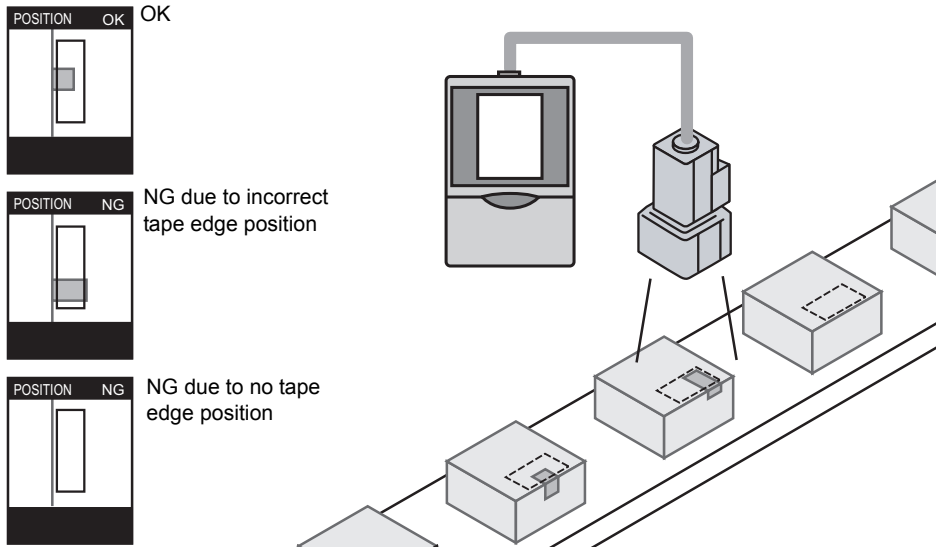

Basic Setting Procedure

■ Teaching

Enclose the area to be inspected using a rectangular box and then perform teaching.

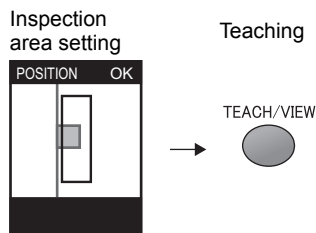

Set so that there is one change in brightness such as "light to dark" or "dark to light" in the inspection area.

■ Adjusting the threshold level

- Switching to ADJ mode

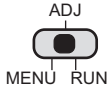

- Adjustment of edge position

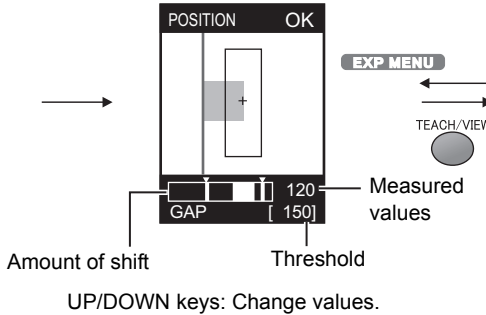

- Adjustment of edge level

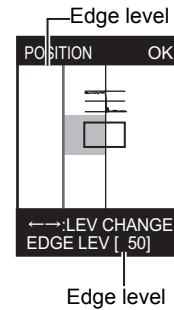

- When edge detection direction is →
UP/DOWN keys: Change values.
- When edge detection direction is ↓
LEFT/RIGHT keys: Change values.

Setting item	Range	Details of Adjustment
Edge position	0 to 468	Amount of shift from reference position
Edge level	0 to 100	This is the density level judged to be an edge. Adjust this level when measurement is unstable. p.73

CUSTOM Menu **EXP MENU**

Items that can be customized

Items that can be customized		Page
Items related to edge detection	Selecting the color of edges	p.77
	Selecting the edge detection direction	p.77
	Changing edge sensitivity	p.77
Items related to color	Changing the color mode (default: [FILTER])	p.74
	Changing the filter color (only when [FILTER] is selected in [COL MODE])	p.65
	Teaching Brightness (only when [PICKUP] is selected in [COL MODE])	p.65

■ Items related to edge detection

Set the direction in which edges are searched and the change in density.

Example)

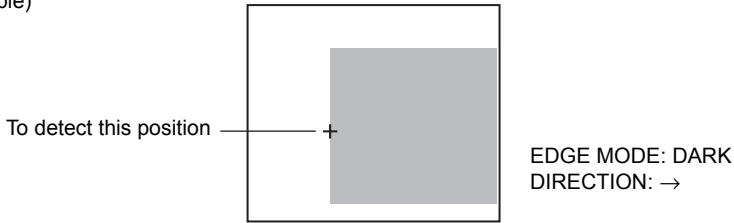

● Selecting the color of edges

Select the direction of density change for the edge to be detected.

▶ MENU mode-[TEACH]-[CUSTM]-[EDGE MODE]

Setting	Details
DARK	Dark areas shown in the filtered monochrome image are assumed to be edges.
LIGHT (default)	Light areas shown in the filtered monochrome image are assumed to be edges.

● Selecting the edge detection direction

Select the direction in which edges are searched.

▶ MENU mode-[TEACH]-[CUSTM]-[DIRECTION]

Setting	Details
↑	Searches from bottom to top.
↓	Searches from top to bottom.
→ (default)	Searches from left to right.
←	Searches from right to left.

● Changing edge sensitivity

Change sensitivity when a stable edge cannot be located.

▶ MENU mode-[TEACH]-[CUSTM]-[EDGE SENSE]

Setting	Details
SENSITIVE	Edge sensitivity is high. Select this when contrast is low and a stable edge cannot be located.
NORMAL (default)	Standard sensitivity.
ROUGH	Edge sensitivity is low. Select this when something like dust is mistakenly detected as the edge.

Inspecting by Count (COUNT)

Select this item when counting the number of workpieces. The edges in the teaching area are detected, and judgment is performed by comparing the number of edges with a reference value. This item is suitable for applications such as inspecting the number of cookies in a box, checking the number of leads and counting cables.



Example: Checking the number of lead

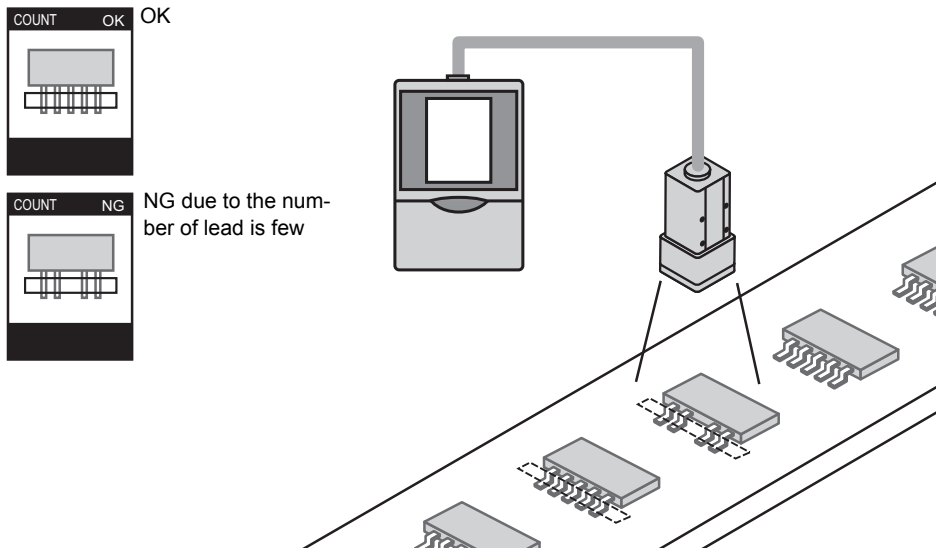

Basic Setting Procedure

■ Teaching

Enclose the area to be inspected using a rectangular box and then perform teaching.

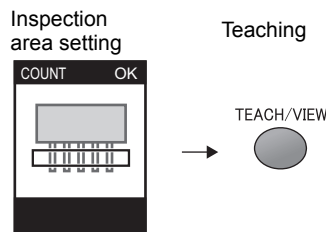

A change in brightness such as "light to dark to light" or "dark to light to dark" is counted as "1". In the above example, the count is 5.

■ Adjusting the threshold level

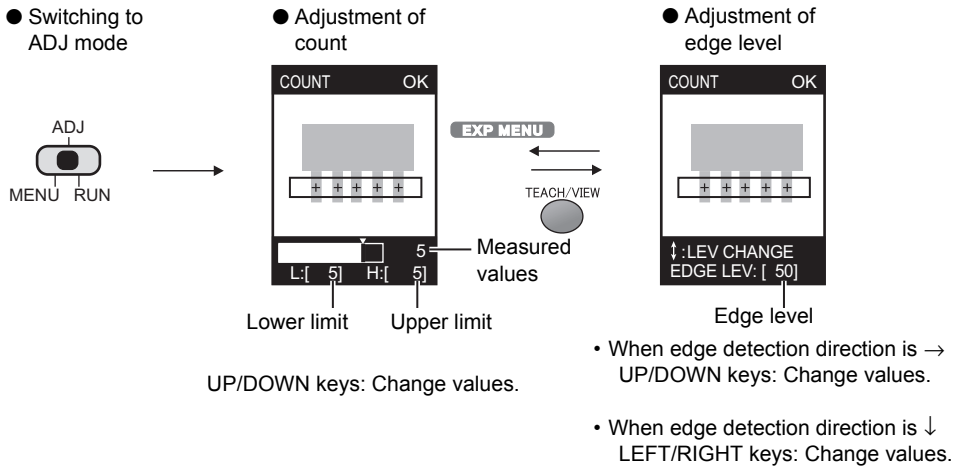

Setting item	Range	Details of Adjustment
Count	0 to 255	Threshold level for counting.
Edge level	0 to 100	This is the density level judged to be an edge. Adjust this level when measurement is unstable. p.73

CUSTOM Menu **EXP MENU**

Items that can be customized

Items that can be customized		Page
Items related to edge detection	Selecting the color of edge	p.80
	Selecting the edge detection direction	p.80
Items related to color	Changing the color mode (default: [FILTER])	p.74
	Changing the filter color (only when [FILTER] is selected in [COL MODE])	p.65
	Changing Brightness during teaching (only when [PICKUP] is selected in [COL MODE])	p.65

■ Items related to edge detection

Set the direction in which edges are searched and the density level.

Example)

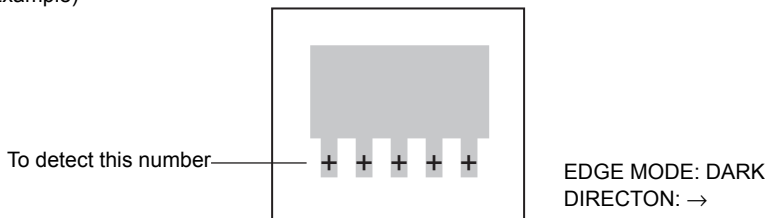

● **Selecting the color of edges**

Select the direction of density change for the edge to be detected.

▶ MENU mode-[TEACH]-[CUSTM]-[EDGE MODE]

Setting	Details
DARK	Dark areas shown in the filtered monochrome image are assumed to be edges.
LIGHT (default)	Light areas shown in the filtered monochrome image are assumed to be edges.

● **Selecting the edge detection direction**

Select the direction in which edges are searched.

▶ MENU mode-[TEACH]-[CUSTM]-[DIRECTION]

Setting	Details
↓	Searches from top to bottom.
→ (default)	Searches from left to right.

Inspecting by Brightness (BRIGHT)

Select this item to detect brightness (density) or scratches/dirt on plain work-pieces.

It is suitable for applications such as checking for dirt on battery surface, scratches on sheets and checking whether LEDs light up properly.



Example: Inspection for Dirt on Battery Surface

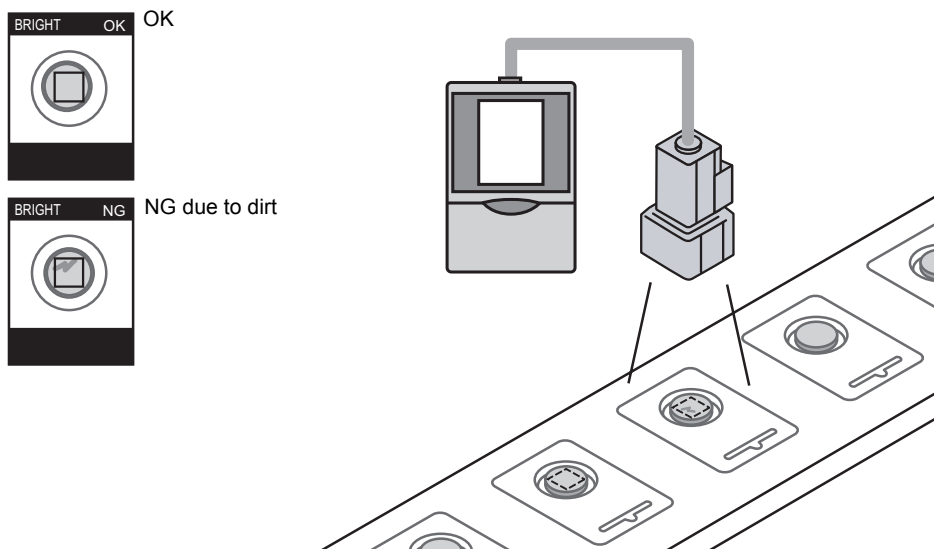

Basic Setting Procedure

■ Teaching

Enclose the area to be inspected using a rectangular box and then perform teaching.

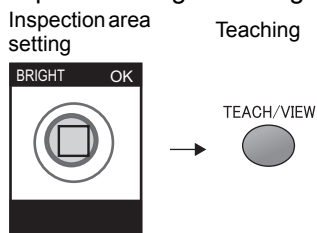

■ Adjusting the threshold level

- Switching to ADJ mode

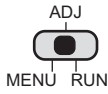

- Adjustment of average density value

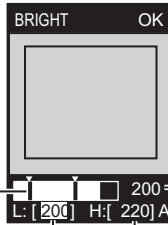

Upper/lower limit Lower limit Upper limit Measured values

LEFT/RIGHT keys: Select upper limit/
 lower limit.
 UP/DOWN keys: Change values.

- Adjustment of density deviation value

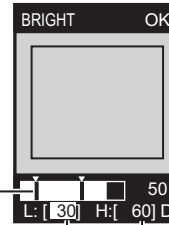

Upper/lower limit Lower limit Upper limit Measured values

LEFT/RIGHT keys: Select upper limit/
 lower limit.
 UP/DOWN keys: Change values.

Setting item	Range	Details of Adjustment
Average density value	0 to 255	Threshold level for the average density in the teaching area.
Density deviation value	0 to 127	Threshold level for the density deviation in the teaching area.

CUSTOM Menu **EXP MENU**

Items that can be customized

Items that can be customized		Page
Items related to brightness	Changing the detection content	p.83
Items related to color	Changing the filter color	p.65

■ Items related to brightness

● Changing the detection content

Select the content to be inspected.

▶ MENU mode-[TEACH]-[CUSTM]-[METHOD]

Setting	Details
AVERAGE (default)	Inspect by brightness (average density value). Whether an object is lighter or darker is detected by referring to the density at teaching.
DEVIATION	Inspect by (density deviation) in density. Select this to detect scratches or dirt.

Teaching image



When [AVERAGE] is selected

OK



NG



NG judged when density is different

NG



When [DEVIATION] is selected

OK

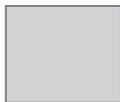

OK judged if there is no density change even if density is different

OK



NG



NG judged if there is density change

NG



Detecting Presence of Character String (CHARA)

Select this item to check for presence of character strings.

There are two measurement items for [CHARA]: [CHARA1] and [CHARA2].



● CHARA1

Select this item to check for presence of the entire character string printed on plain background. Judgment is performed by monitoring changes in density (brightness) of the registered character string. Errors in characters, missing dots, etc. cannot be detected. This item is suitable for applications such as detection of presence of prints on chips and presence of entire characters of the best-before date.

Example: Detection of presence of prints on chip

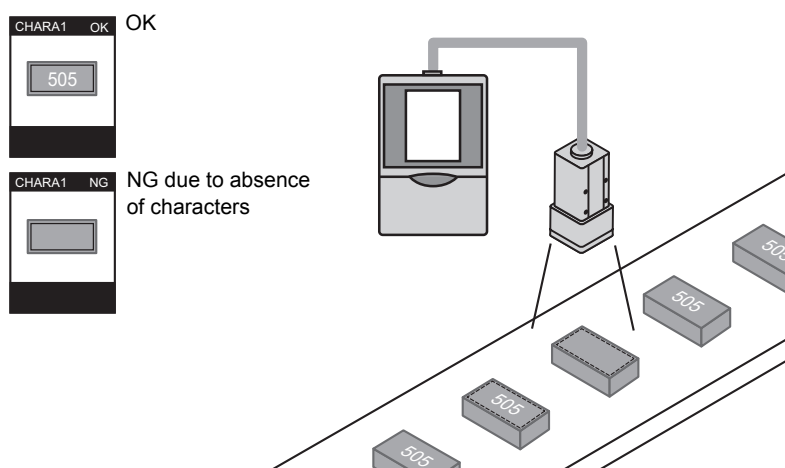

● CHARA2

Select this item to detect omission of single characters.

Errors in single characters, missing dots, etc. cannot be detected. This item is suitable for applications such as detection of missing character in character strings such as the best-before date.

Example:

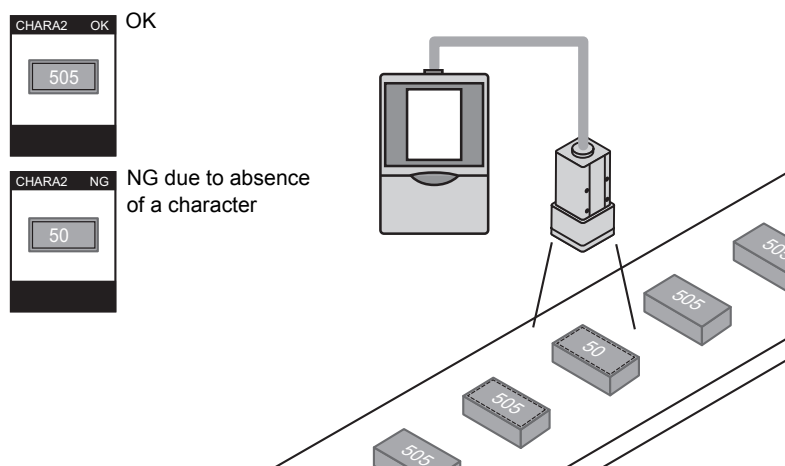

Basic Setting Procedure

■ Teaching

Enclose the area to be inspected using a rectangular box and then perform teaching.

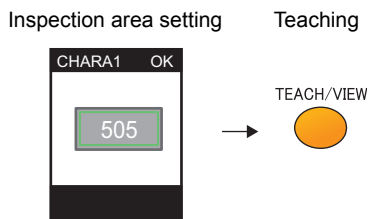

Teaching area for [CHARA]

For the teaching area when the printing position is out of position, set to an area in which the character string might possibly be printed out of position. (Be sure, however, to set to an area having a plain background.)

If an area very close to the character string without any margin is set, the sensor will not be able to track any shift in the printing position.

Right

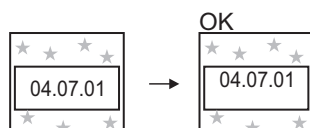

Any shift of the printing position inside the teaching area is judged as OK.

Wrong



When the teaching area is set very close to the character without any margin, character protrudes from the teaching area and so this is judged as an NG.

■ Adjusting the threshold level

● CHARA1

- Switching to ADJ mode

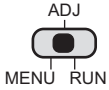

- Adjustment of correlation value

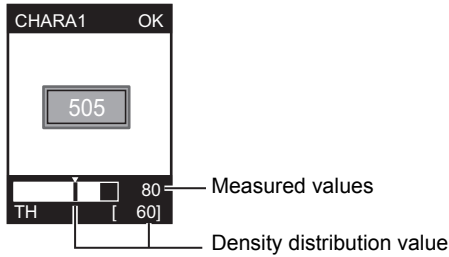

UP/DOWN keys: Change values.

Setting item	Range	Details of Adjustment
Density distribution value	0 to 100	This is the value that is judged as OK when the density deviation value during teaching is taken to be 100%.

● CHARA2

- Switching to ADJ mode

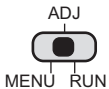

- Adjustment of correlation value

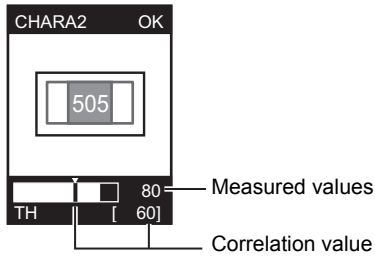

UP/DOWN keys: Change values.

Setting item	Range	Details of Adjustment
Correlation value	0 to 100	This is the lower limit of the correlation value with the teaching model. This value or above is judged as OK.

CUSTOM Menu EXP MENU

Items that can be customized

	Items that can be customized	Page
Items related to character	Setting the model registration conditions for characters (Only when [CHARA2] is selected)	p.87
	Selecting whether or not to perform position compensation	p.88
	Changing the search area	p.90
	Raising detection stability (Only when [CHARA2] is selected)	p.90
Items related to color	Changing the filter color	p.65

■ Items related to character

● Setting the model registration conditions for characters

This item is displayed only when [CHARA2] is set.

Select the number of characters in the preset teaching area.

Select the number of characters being within a certain number of characters on one or two lines.

Selection guidelines

- 8 characters, 1 line

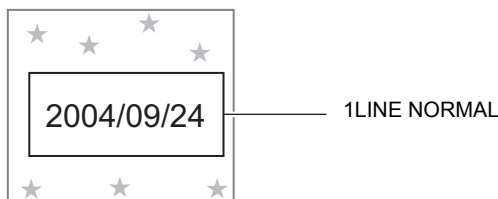

- 8 characters, 2 line

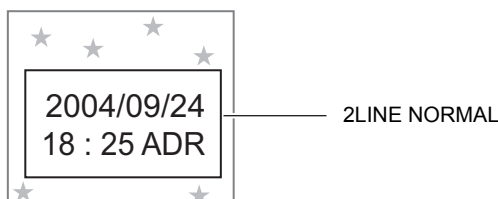

▶ MENU mode-[CUSTM]-[MDL DIV]

Setting	Details
1LINE SHORT	Select this when the character string consists of 1 line, 6 characters or less.
1LINE NORMAL (default)	Select this when the character string consists of 1 line, 8 characters or less.
1LINE LONG	Select this when the character string consists of 1 line, 15 characters or less.
2LINE SHORT	Select this when the character string consists of 2 lines, 6 characters or less.
2LINE NORMAL	Select this when the character string consists of 2 lines, 8 characters or less.



The number of characters in the above table are for reference only. When there are more characters than the number of reference characters in the selected item, measurement accuracy drops.

CHECK!

Section 4 Detecting Presence of Character String (CHARA)

● Selecting whether or not to perform position compensation

Set position compensation for improving detection accuracy in the following instances:

When printed text is out of position



When there is a pattern in the detection range

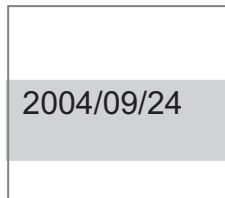

▶ MENU mode-[CUSTM]-[MODE]

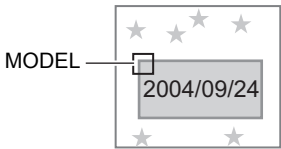
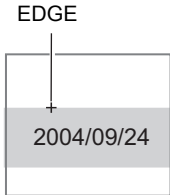
Setting	Details
NONE	The position is not corrected.
MODEL	The model is used to correct the position. Select this when there is a characteristics part such as a corner of a text box. 
EDGE	The edge position is used to correct the position. 

• Registering models

Registration of model is necessary if [MODEL] has been selected for [MODE].

Specify the top left coordinate and bottom left coordinate of the model.

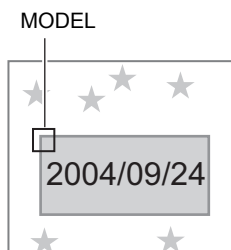

▶ MENU mode-[CUSTM]-[MODE DTL]-[MODEL]

• Specifying edge detection conditions

Set the edge detection conditions when [EDGE] is selected for [MODE].

Set the direction in which edges are searched and the density level.

Example)

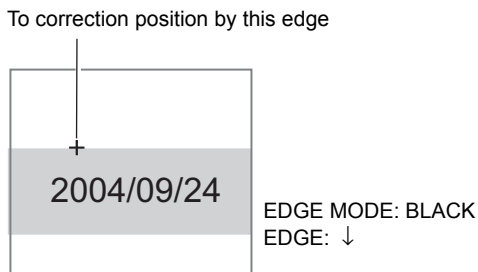

• Selecting the color of edge

Select the direction of density change for the edge to be detected.

▶ MENU mode-[CUSTM]-[MODE DTL]-[EDGE MODE]

Setting	Details
DARK (default)	Dark areas shown in the filtered monochrome image are assumed to be edges.
LIGHT	Light areas shown in the filtered monochrome image are assumed to be edges.

• Selecting the edge detection direction

Select the direction in which edges are searched.

▶ MENU mode-[CUSTM]-[MODE DTL]-[DIRECTION]

Setting	Details
↑ (default)	Searches from bottom to top.
↓	Searches from top to bottom.
→	Searches from left to right.
←	Searches from right to left.

Section 4 Detecting Presence of Character String (CHARA)

● Changing the search area

Change the area to search edges or the model.

Specify the top left coordinate and bottom left coordinate of the area.

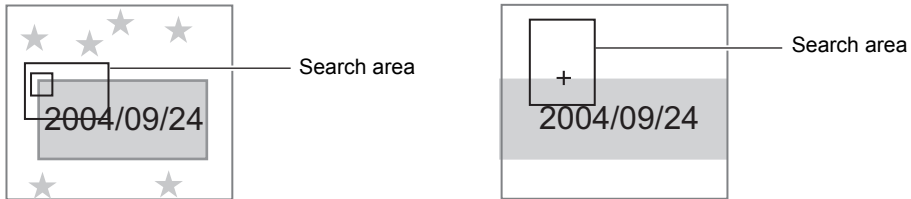

▶ MENU mode-[CUSTM]-[MODE DTL]-[SEARCH AREA]



When searching edges

Measurement can be performed only when the search area contains an edge. Determine the size and position of the area taking the movement range of the workpiece into consideration.

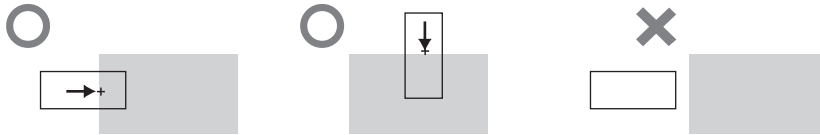

● Raising detection stability

This item is displayed only when [CHARA2] is set.

▶ MENU mode-[CUSTM]-[STABLE]

Setting	Details
OFF (default)	Standard detection method.
ON	Detailed detection method. The process time is longer than OFF.

Section 5

SETTING ADDITIONAL FUNCTIONS

☒	Setting Image Acquisition Conditions	92
	Adjusting Light Intensity and Shutter Speed	92
	Changing the Image Display Position (Partial Function)	93
	Increasing the Sensor Head Sensitivity	93
☒	Setting Conditions Related to Bank	94
	Copying Banks	94
	Clearing Banks	95
	Setting the Bank Switching Method	95
☒	Setting the System Environment	96
	Changing the Measurement Speed	96
	Selecting the Measurement Timing	97
	Selecting the Teaching Mode from an External Device	97
	Setting Screen Display	97
	Setting/Cancelling the Eco Mode	98
	Changing Image Capture Timing on Teaching Screen	98
	I/O Monitor Function	99
	Correcting White Balance	100
	Initializing the Setup Data	100
	Initializing Measurement Data	101
	Switching the Language	101
	Checking the Version	101
☒	Setting USB/RS-232C Communication Specifications	102
☒	Restricting Operations (Lock Function)	105
	Setting the Lock Function	105
	Starting/Cancelling the Lock Function	106
	Lock Function during Gang-Mounting	106
☒	Changing OUTPUT Signal Output Conditions	107
☒	Setting for Amplifier Unit Gang-Mount	110

Setting Image Acquisition Conditions

Adjusting Light Intensity and Shutter Speed

EXP MENU

The intensity of the light from Sensor Head and shutter speed can be adjusted. [AUTO] is selected as the default setting.

► MENU mode-[IMAGE]-[CONTRAST]

Setting		Details
AUTO (default)		Light intensity and shutter speed are adjusted automatically.
FIX	LIGHT	The light intensity can be set for each side. 0: Out, 1 to 5: Light intensity increases according to the number. (0 to 5, default: 5) This menu is not displayed if ZFV-SC150/SC150W is connected.
	SHUTTER (default)	1/500, 1/1000, 1/1200, 1/1400, 1/1500, 1/2000, 1/2500, 1/3000, 1/4000, 1/8000 ("1/500" can be set only when the light intensity is set to "0000".)

■ Lighting

The light intensity is displayed as a 4-digit number. One digit shows the light intensity for one of four sides is displayed as a 4-digit number.

Top surface (model printed surface)

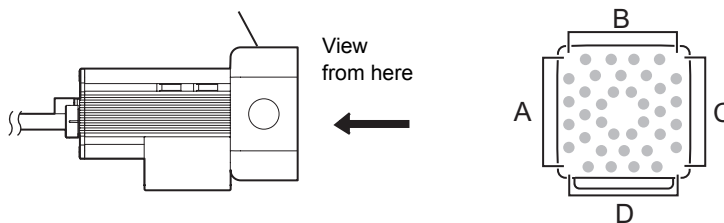

An image of how light is emitted is displayed on screen.

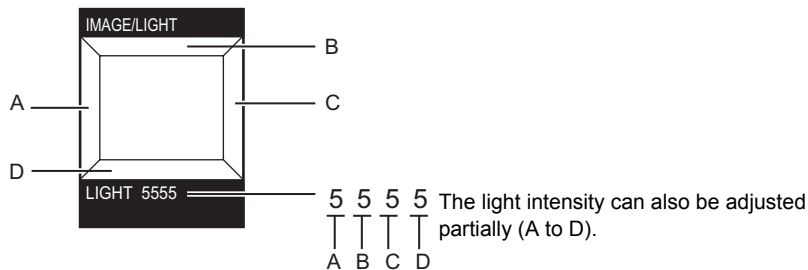

1. Select the light intensity by the UP/DOWN keys.

For partial adjustment

- LEFT/RIGHT keys: Select the side that is adjusted.
- UP/DOWN keys: Select the light intensity.

2. Press the SET Key to fix the setting.

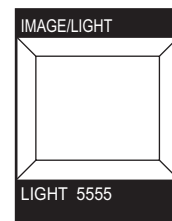

Changing the Image Display Position (Partial Function)

EXP MENU

ZFV-C allows you to increase the processing speed by narrowing the image acquisition area. The image area can be moved, when measurement speed is FAST mode (1/2 screen) or MAX mode (1/4 screen).

 Changing the Measurement Speed p.96

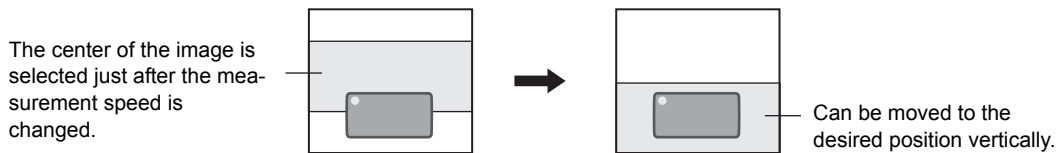

► MENU mode-[IMAGE]-[DISP POS]

1. Move the image area using the UP/DOWN keys.
2. Press the SET Key to fix the setting.

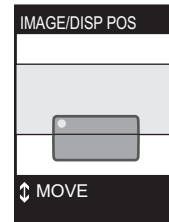

Increasing the Sensor Head Sensitivity

EXP MENU

If the image brightness cannot be increased by either shutter speed or lighting setting, increase the sensitivity magnification.

► MENU mode-[IMAGE]-[GAIN]

Setting value (magnification)	Quality	Image
X1.0	Good (small amount of noise)	Dark
X1.5	↑ ↓	↑ ↓
X2.0	Bad (larger amount of noise)	Bright

Setting Conditions Related to Bank



ZFV-C can hold up to eight sets of settings. These settings can be switched according to inspection conditions. A set of these settings is called a “bank”.

Copying Banks

Copy the settings of one bank to another bank.

The following example shows the procedure for copying the settings of BANK 1 to BANK 2.

► MENU mode-[SYS1]-[BANK SET]-[COPY]

1. Make the settings that are required to perform inspection at BANK 1 (copy source).
2. Switch to MENU mode.
3. Select  and press the SET key.
4. Select [2. BANK2] and press the SET key.
5. Select  and press the SET key.
6. Select [1. BANKSET] - [1. COPY] - [1. BANK1] (copy source).
Press the ESC Key twice to return to MENU mode.
7. Switch to RUN mode and save the settings.

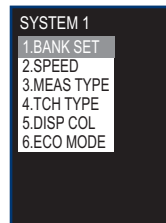
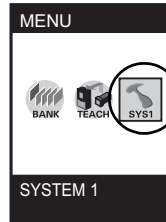
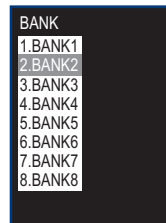
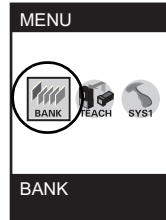
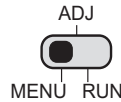

Clearing Banks

“Clearing” deletes the settings of the selected bank number.

▶ MENU mode-[SYS1]-[BANK SET]-[CLEAR]

Settings	Description
EXECUTE	Executes clear.
CANCEL	Cancel clear.



[SYS1], [SYS2] settings and RUN mode display settings will not be cleared.

CHECK!

Setting the Bank Switching Method

Select how to switch banks.

▶ MENU mode-[SYS1]-[BANK SET]-[SWITCH]

Setting	Description
KEY (default)	Banks are switched by the control keys on Amplifier Unit.
I/O	Banks are switched by the control keys on Amplifier Unit and by external signals. Switching by external signals is enabled only in the RUN mode.



Switching to Another Bank p.58



To switch a bank using a command via USB/RS-232C, select [SWITCH]-[KEY].

CHECK!

Setting the System Environment

Changing the Measurement Speed

The processing speed can be increased by narrowing the image acquisition area. Change the measurement speed according to the size of workpiece and required speed.

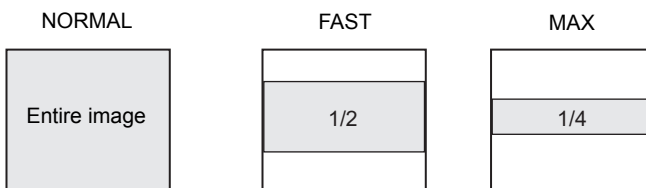

► MENU mode[SYS1]-[SPEED]

Setting	Details
NORMAL (default)	Acquires the entire image. (13 ms)
FAST	Narrows the image acquisition area to 1/2. This will increase the measurement speed. (8 ms)
MAX	Narrows the image acquisition area to 1/4. This will increase the measurement speed. (5 ms)



- If [FAST] or [MAX] is selected, it is possible to select the part of the screen to be inspected.



Changing the Image Display Position (Partial Function) p.93

CHECK!

- If [FAST] or [MAX] is selected, make sure that the inspection area and color selection area are within the displayed image.

Selecting the Measurement Timing

Set the timing that measurement is executed.

► MENU mode-[SYS1]-[MEAS TYPE]

Setting	Details
TRIG (default)	Synchronous measurement Measurement is performed in synchronous with the change in state of the external TRIG signal from OFF to ON.
CONTINUE	Continuous measurement Measurement is repeatedly performed for the duration that the TRIG signal is ON.

Selecting the Teaching Mode from an External Device

There are two teaching modes from an external device.

► MENU mode-[SYS1]-[TEACH TYPE]

Setting	Details
STATIONARY (default)	Teaching is performed with the workpiece in a stationary state. Input of the external trigger is required for teaching.
MOVING	The teaching is performed with the moving workpiece. Select this teaching mode only when the workpiece cannot be stopped. Input of the external trigger is required for teaching.

 Timing Charts p.42

Setting Screen Display

The color of characters displayed on the LCD monitor and monitor's background color can be changed. Change the color when it is difficult to see the character or figure on the image.

- Areas whose color can be changed

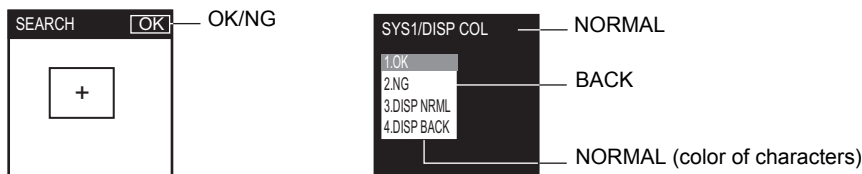

► MENU mode -[SYS1]-[DISP COL]

	Setting
OK	GREEN (default), RED, YELLOW, BLUE, WHITE
NG	GREEN, RED (default), YELLOW, BLUE, WHITE
NORMAL	GREEN, RED, YELLOW, BLUE, WHITE (default)
BACK	GREEN, RED, YELLOW, BLUE (default), WHITE, BLACK

Setting/Cancelling the Eco Mode

Whether or not to darken the screen when a preset time has passed without any operation.

We recommend setting this mode to [ON] to prevent the brightness of the LCD screen from being impaired.

► MENU mode-[SYS1]-[ECO MODE]

Setting	Details
ON (default)	Sets the Eco mode. The screen darkens when three minutes continue without any operation.
OFF	Cancels the Eco mode setting.

Changing Image Capture Timing on Teaching Screen

EXP MENU

Select status of image to be displayed on the teaching screen.

► MENU mode-[SYS2]-[TEACH IMAGE]

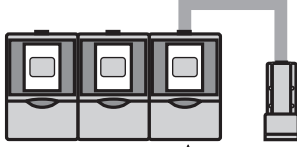
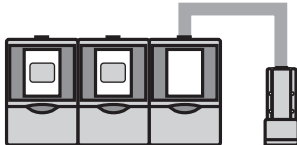
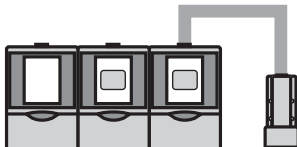
Setting	Description
THROUGH (default)	The latest image taken by the Sensor Head is displayed directly.
FREEZE	<p>Freeze the image and display. The still image is displayed when the TRIG signal is input.</p> <p> CHECK! When amplifier units are gang-mounted, set all amplifier units to the teaching screen then input the TRIG signal to the amplifier unit (furthest to the right) where the sensor head is connected.</p> <div style="display: flex; flex-direction: column; align-items: center;"> <div style="display: flex; align-items: center; margin-bottom: 10px;"> <div style="font-size: 2em; margin-right: 10px;">○</div>  <div style="margin-left: 10px;">Images are loaded to all amplifier units when all amplifier units are set to the teaching screen.</div> </div> <div style="display: flex; align-items: center; margin-bottom: 10px;"> <div style="font-size: 2em; margin-right: 10px;">×</div>  <div style="margin-left: 10px;">Images are not loaded to all amplifier units when the amplifier where the sensor head is connected is not set to the teaching screen.</div> </div> <div style="display: flex; align-items: center;"> <div style="font-size: 2em; margin-right: 10px;">×</div>  <div style="margin-left: 10px;">Images are not loaded to the far left amplifier when the far left amplifier is not at the teaching screen.</div> </div> </div>

I/O Monitor Function

EXP MENU

This is a function to check the status of I/O signals.

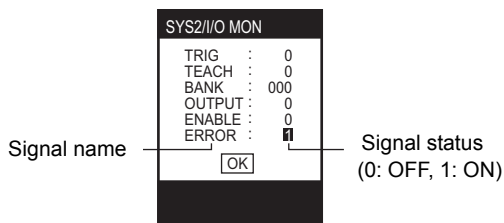

▶ MENU mode-[SYS2]-[I/O MON]

Setting	Details
TRIG	Displays ON/OFF status of TRIG signal. (0: OFF, 1: ON)
TEACH	Displays ON/OFF status of TEACH signal. (0: OFF, 1: ON)
BANK	Displays ON/OFF status of BANK signal. (0: OFF, 1: ON) Expresses BANK1, BANK2, BANK3 sequentially from the right.
OUTPUT	Displays ON/OFF status of OUTPUT signal. (0: OFF, 1: ON)
ENABLE	Displays ON/OFF status of ENABLE signal. (0: OFF, 1: ON)
ERROR	Displays ON/OFF status of ERROR signal. (0: OFF, 1: ON)



CHECK!

Put the cursor on OUTPUT, ENABLE and ERROR, then press the SET button key to switch between "0" and "1". The external device operations can be checked by switching output OFF/ON when the actual measurements are not being performed.

Correcting White Balance

EXP MENU

Due to influences by sensor head's surrounding and lighting, the image taken by the camera sometimes contains colors even if the object is white.

The function to correct the color of a white object so that the object is displayed as white is called white balance.

▶ MENU mode-[SYS2]-[WHITE BAL]

1. Display a white object (e.g. paper, cloth) on the monitor.
2. Press the TEACH/VIEW key while "OK" is displayed at the lower left of the screen.

White balance will be adjusted.



CHECK!

If a character other than "OK" is displayed at the lower left of the screen, exit from the white balance window and perform above steps again. If "OK" still does not appear, perform the following.

- When "TOO BRIGHT" is displayed
The screen is too bright.
- When "TOO DARK" is displayed
The screen is too dark.
- When "BAD BALANCE" is displayed
The workpiece is not displayed as a white object. First, make sure that the correct white workpiece is displayed.



Setting Image Acquisition Conditions p.92

Initializing the Setup Data

EXP MENU

Return all bank settings and system settings (excluding message display language) to the factory settings.



CHECK!

The settings of all banks and system settings are initialized regardless of the currently selected bank No.

▶ MENU mode-[SYS2]-[ALL CLEAR]

Setting	Description
EXECUTE	Initialize set up data.
CANCEL	Do not initialize set up data.

Initializing Measurement Data

EXP MENU

Current and past measurement average values, measurement count and other measurement data can be cleared without restarting.

Data to be cleared are the items displayed in the following screen at RUN mode.

SEARCH	OK
JG	: OK
SCORE	: 98
TH	: 60
AVE	: 0
DRANGE	: 0-100
MCONT	: 2
NG%	: 1.000
TIME	: 144



Meaning of display contents p.55

► MENU mode-[SYS2]-[MEAS CLEAR]

Setting	Description
EXECUTE	Initialize measurement data.
CANCEL	Do not initialize measurement data.

Switching the Language

EXP MENU

Switch the language for displayed messages between Japanese and English.

► MENU mode-[SYS2]-[LANGUAGE]

Setting	Description
ENGLISH	Displays messages in English.
JAPANESE	Displays messages in Japanese.

Checking the Version

EXP MENU

Displays the type of Sensor Head, type of Amplifier Unit and system version information of the software.

► MENU mode-[SYS2]-[VERSION]

Setting USB/RS-232C Communication Specifications

Set the communication specifications of the Amplifier Unit according to those of external devices.



For details on communication commands, refer to the "Communication Command Reference" (provided separately).

CHECK!

For the "Communication Command Reference", contact OMRON sales staff.



Before connecting/disconnecting external devices, make sure that the Amplifier Unit is turned OFF. Breakdown or accidents may occur if this is done with the Amplifier Unit turned ON.

CHECK!

USB Connection

■ Connection

1. Install the USB driver to the personal computer.

For the USB driver, please contact your OMRON representative.

Installation of the USB driver is necessary only when connecting an external device to the USB interface for the first time.

2. Insert one end of the USB cable to the USB connector on the Amplifier Unit.

3. Insert the other end of the USB cable to the USB connector of the external device.

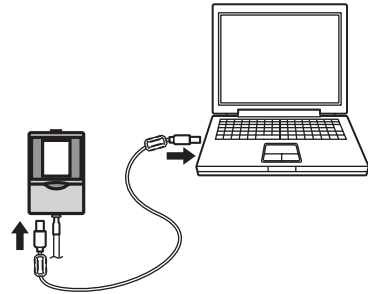

■ Setting communication specifications

Set the communication specifications of the Amplifier Unit according to those of external devices.

▶ MENU mode-[SYS2]-[COM]

Setting	Description
LENGTH	The settings will be ignored.
PARITY	
STOP BIT	
BAUDRATE	
NODE	
DELIMIT	CR, LF, CR+LF (default: CR)

RS-232C Connection

■ Connection

1. Insert one end of the RS-232C cable to the RS-232C connector on the Amplifier Unit.
2. Insert the other end of the RS-232C cable to the RS-232C connector of the external device.

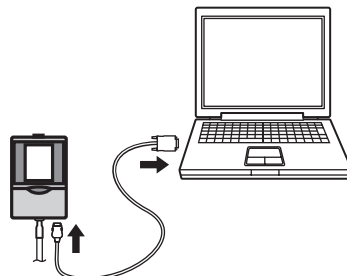

- RS-232C cable for connecting a programmable controller
 - RS-232C cable
 - ZS-XPT2 (cable length: 2 m)

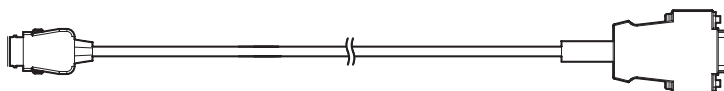

Amplifier unit side

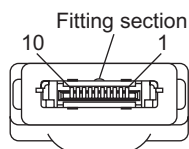

PLC side (Note 1)

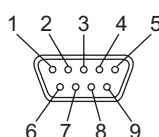

Signal name	Pin No.
NC	1
SD(TXD)	2
RD(RXD)	3
RS(RTS)	4
CS(CTS)	5
NC	6
NC	7
NC	8
SG(GND)	9
NC	10

Pin No.	Signal name
1	NC
2	SD(TXD)
3	RD(RXD)
4	RS(RTS)
5	CS(CTS)
6	NC
7	NC
8	NC
9	SG(GND)

Note 1: A plug type connector is used for the PLC side.

Section 5 Setting USB/RS-232C Communication Specifications

● RS-232C cable for connecting a personal computer

- ZS-XRS2 (cable length: 2 m)

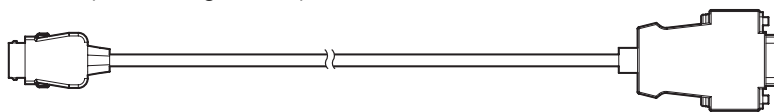

Amplifier unit side

PC side (PC/AT compatible) (Note 1)

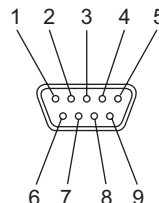
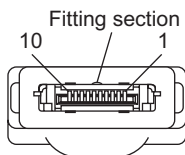

Signal name	Pin No.
NC	1
SD(TXD)	2
RD(RXD)	3
RS(RTS)	4
CS(CTS)	5
NC	6
NC	7
NC	8
SG(GND)	9
NC	10

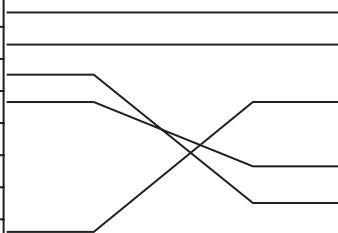

Pin No.	Signal name
1	NC
2	RD(RXD)
3	SD(TXD)
4	NC
5	SG(GND)
6	NC
7	RS(RTS)
8	CS(CTS)
9	NC

Note 1: A socket type connector is used for the PC side.

■ Setting communication specifications

Set the communication specifications of the Amplifier Unit according to those of external devices.

▶ MENU mode-[SYS2]-[COM]

Setting	Description
LENGTH	7, 8 (default)
PARITY	OFF (default), ODD, EVEN
STOP BIT	1 (default), 2
BAUDRATE	9600, 19200, 38400 (default), 57600, 115200
NODE	0 (default) to 16 Node No. indicates a connection group No. viewed from a host device (programmable controller). Not only ZFV-C but also two or more devices can be connected to the programmable controller. Numbers assigned to the devices connected to the programmable controller are called node Nos.
DELIMIT	CR (default), LF, CR+LF

Restricting Operations (Lock Function)

Setting the Lock Function

EXP MENU

Set the lock function to restrict switch and key operations.

By restricting switch and key operations, unintended changes in settings can be prevented.

Three types of operations, "mode switch", "key input", and "TEACH signal input", can be locked.

► MENU mode-[SYS2]-[LOCK]

Standard value	Description
MODE SWITCH	Operation of the mode switch (MENU/ADJ/RUN) is restricted. (Lock OFF (default), Lock ON)
KEY	Operation of keys (SET, ↑ ↓ ← →, TEACH/View, and function keys A through D) is restricted. (Lock OFF (default), Lock ON)
TEACH IN	TEACH signal input is restricted. (Lock OFF (default), Lock ON)
PASS NUMBER	The number for cancelling the lock function is set. (Default: 0000)



CHECK!

When mode switch operation is enabled, key operation and TEACH signal input cannot be disabled.

Starting/Cancelling the Lock Function

EXP MENU

Set the [PASS NUMBER] required for cancelling the lock function before starting the function.

■ Starting

1. In the RUN mode, press the ESC key for at least two seconds.

A start confirmation message will appear.



The start confirmation message will not appear unless an item to be restricted is set.

CHECK!

2. Select [EXECUTE].

The lock function is started.

A key mark is displayed in the upper-right corner of the screen while the lock function is ON (see the illustration).

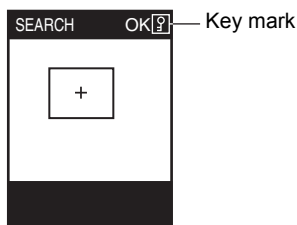

■ Cancelling

1. Switch to the RUN mode and press the ESC key for at least two seconds.

A cancel confirmation message will appear.

2. Select [EXECUTE].

The pass number input screen will appear.

3. Input the pass number.

The lock function is cancelled.

Lock Function during Gang-Mounting

During gang-mounting, the lock function can be started or cancelled only on the host device. With respect to this function, the client is in the same status as the host device.

Changing OUTPUT Signal Output Conditions

Selecting the ON Conditions

EXP MENU

Set whether to turn the OUTPUT signal ON when OK is judged or when NG is judged.

► MENU mode-[SYS2]-[OUTPUT]-[ON STATUS]

Setting	Details
OK ON	Turns the OUTPUT signal ON when OK is judged.
NG ON (default)	Turns the OUTPUT signal ON when NG is judged.

One-shot Output

EXP MENU

OUTPUT turns ON for only the preset output time from when the OUTPUT signal turns ON.

● Synchronous measurement

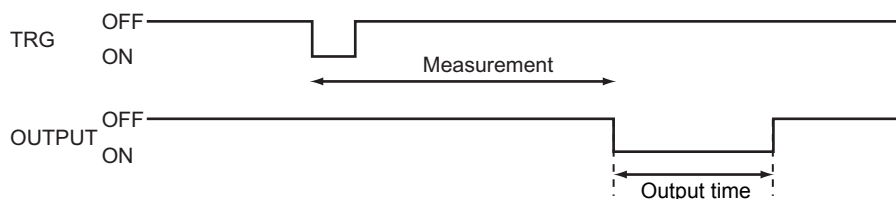

● Continuous measurement

OUTPUT ON at OK judgment

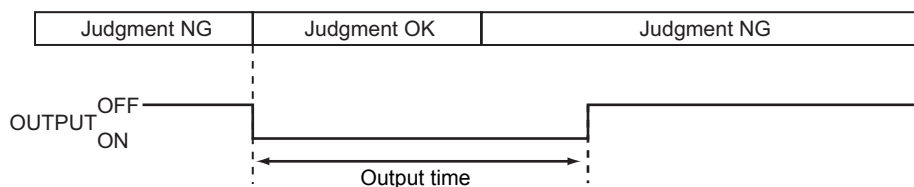

■ Selecting One-Shot output ON/OFF

Set whether or not to enable one-shot output on the OUTPUT signal.

▶ MENU mode-[SYS2]-[OUTPUT]-[ONE SHOT]

Setting	Details
OFF (default)	One-shot output is not performed.
ON	One-shot output is performed.



When one-shot output is set to [ON], the OFF delay time setting is disabled.

CHECK!

■ Setting the One-Shot output Time

EXP MENU

OUTPUT turns ON for the preset time from when the OUTPUT signal turns ON. This setting is valid only when [ONE SHOT] is set to [ON].

▶ MENU mode-[SYS2]-[OUTPUT]-[OUTPUT TIME]

Setting	Details
0 to 255 (default: 0)	Set the time (ms) that OUTPUT is turned ON.

Setting the ON Delay Time

EXP MENU

Set this item to delay the timing that the OUTPUT signal turns ON.

OUTPUT ON at OK judgment in continuous measurement

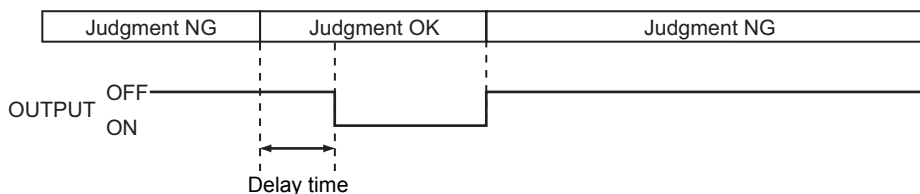

▶ MENU mode-[SYS2]-[OUTPUT]-[ON DELAY]

Setting	Details
0 to 255 (default: 0)	Set the time (ms) to delay turning OFF of the OUTPUT signal.

Setting the OFF Delay Time

EXP MENU

Set this item to delay the timing that the OUTPUT signal turns OFF.

OUTPUT ON at OK judgment in continuous measurement

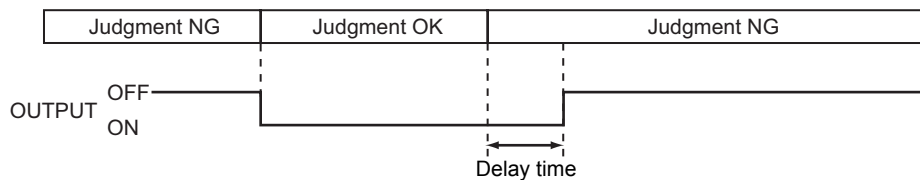

► MENU mode-[SYS2]-[OUTPUT]-[OFF DELAY]

Setting	Details
0 to 255 (default: 0)	Set the time (ms) to delay turning OFF of the OUTPUT signal.

Setting for Amplifier Unit Gang-Mount

The gang-mount related menus are displayed only when Amplifier Unit are gang-mounted. These settings must be made to each Amplifier Unit.

● Example 1: 1 sensor head + multiple amplifier units

Example of detection of input image from 1 sensor head with multiple amplifier units.

- To detect multiple areas such as a 4-sided POSITION, multiple item SEARCH, etc.
- To detect multiple types such as both SEARCH and AREA judgments.

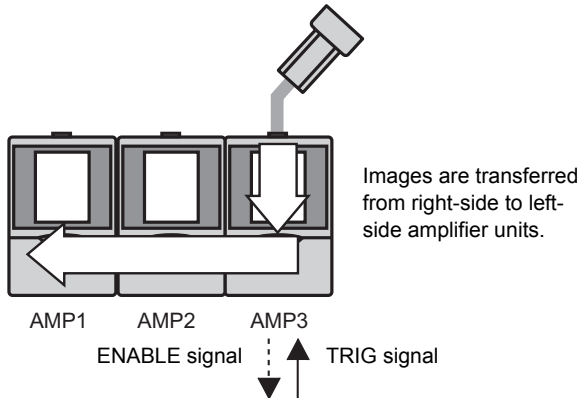

MENU	AMP1/2	AMP3
TRIG	LINK	I/O
HEAD	NOTUSE	USE
LINKOUT	-	All

● Example 2: Multiple sensor heads + multiple amplifier units

Example of synchronizing and detecting multiple points of the same workpiece and integrating judgments.

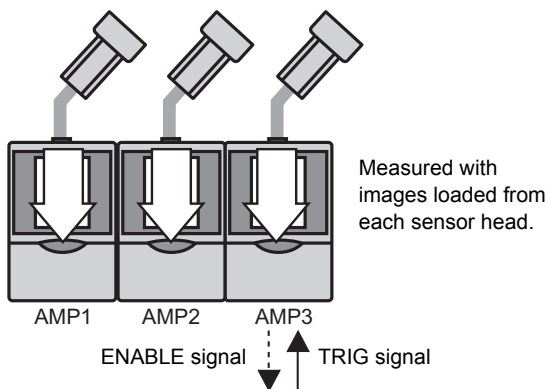

MENU	AMP1/2	AMP3
TRIG	LINK	I/O
HEAD	USE	USE
LINKOUT	-	All

Specifying the Amplifier Unit to Input the Trigger

EXP MENU

Set whether or not to input the TRIG signal to an Amplifier Unit.

► MENU mode-[SYS2]-[LINKSET]-[TRIG]

Setting	Details
I/O (default)	Set to only the Amplifier Unit to which the TRIG signal is to be input.
LINK	Synchronizes to the TRIG signal from the Amplifier Unit gang-mounted on the right side. All the Amplifier Units except for the rightmost one are set to [LINK] automatically.

Setting the Presence of Sensor Head

EXP MENU

Set whether or not a Sensor Head is connected.

► MENU mode-[SYS2]-[LINKSET]-[HEAD]

Setting	Details
USE (default)	Select this for Amplifier Unit to which a Sensor Head is currently connected. Measurement is performed using the input image from the currently connected Sensor Head.
NOT USE	Select this for Amplifier Unit to which a Sensor Head is currently not connected. Measurement is performed from the image transferred from the Sensor Head gang-mounted on the right side.

Setting Output Content

EXP MENU

Set the output content of the measurement result output cable.

This item is displayed only the Amplifier Unit whose [TRIG/TRIG] setting is set to [I/O].

► MENU mode-[SYS2]-[LINKSET]-[OUTPUT]

Setting	Details
ALL	The measurement results of all gang-mounted Amplifier Units are integrated, and output as an overall judgment result.
EACH (default)	The measurement result of each Amplifier Unit is output from the respective Amplifier Unit.

 Output image p.115

Rules of Gang-Mounting

Item	Rules
No. of Amplifier Units connectable	5 or less (power must be supplied to each Amplifier Unit)
No. of mounted sensor heads	Up to the number of amplifier units
TRIG signal input	Only host device is enabled
TEACH signal input	Only host device is enabled
BANK1-3 input	Enabled at each amplifier unit
ENABLE output	Only host device is enabled
OUTPUT output	Depends on the settings (Integrated judgment/Individual judgment)
ERROR output	Enabled at each amplifier unit
MENU/ADJ/RUN	Only host device is enabled
STD/EXP	Enabled at each amplifier unit
All key inputs	Enabled at each amplifier unit

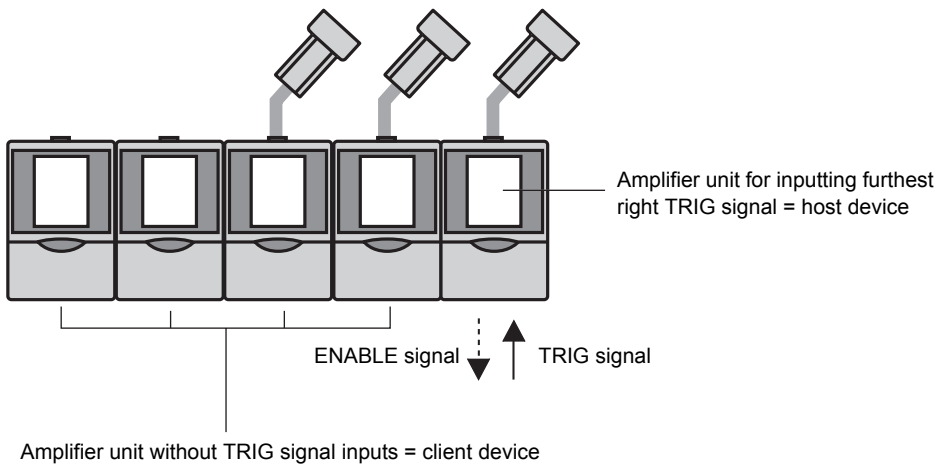

Data Route

■ Measurement image

The measurement image flows from the right-side amplifier unit towards the left-side. Image input timing delays do not occur.

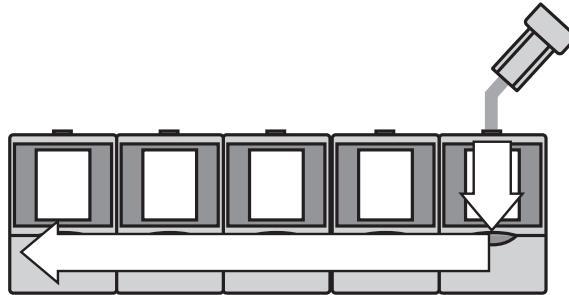

■ I/O signal

The TRIG signal flows from the right-side amplifier unit towards the left-side. Input timing delays do not occur.

In contrast, ENABLE signals and OUTPUT signals combining all amplifying units can be output from the furthest right amplifier unit as ENABLE signals and OUTPUT signals flow from the left-side amplifier unit to the right-side.

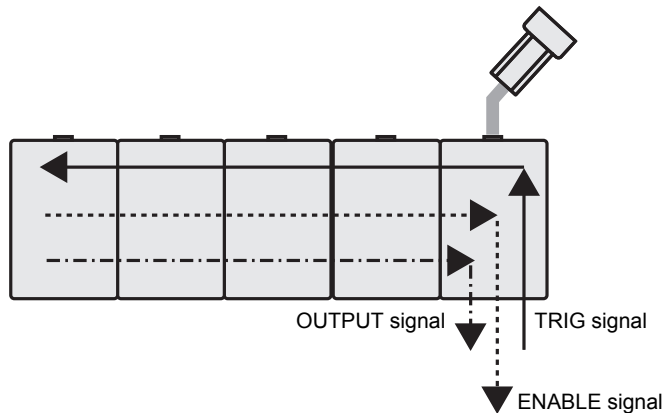

Teaching Process when Gang-Mounting

■ Teaching (key input) from MENU mode

Enter the teaching screen from the host device and press the TEACH key to teach all clients in the teaching screen where the host device is added.

Enter the teaching screen for the client only and press the TEACH key to teach only this client.

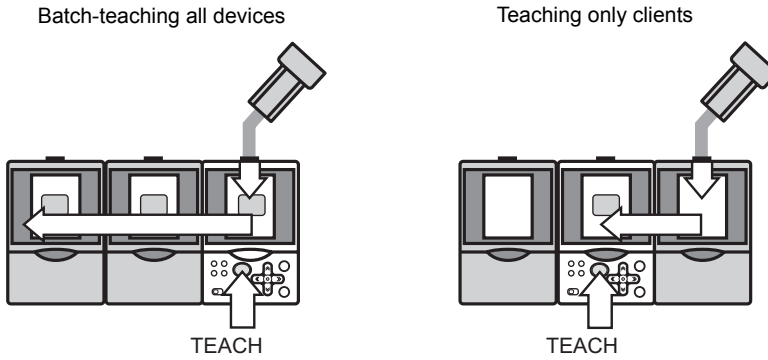

■ External teaching

The TEACH signal is input from the host device. Input the host device ENABLE signal at ON. Teaching is completed when the host device ENABLE signal is set OFF → ON after teaching is performed. It is ignored even if a TEACH signal is input to the client.

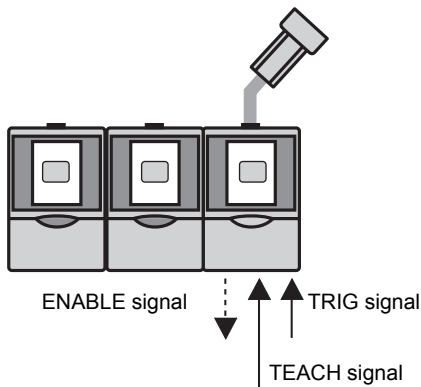

The time required to perform the teaching process increases when gang-mounted. In particular, when performing move teaching, raise the TRIG signal input interval to 200 ms minimum.

CHECK!

Integrating Judgment Output

Judgment result output (OUTPUT) of gang-mounted amplifier units can be integrated.

 Setting output content p.111

■ When all amplifier unit measurement results are integrated (ALL)

Select [ALL] to integrate measurement results of all gang-mounted amplifier units and output from amplifier units (host device) where TRIG signals are input. Obtain OUTPUT signal after ENABLE signal is set to ON.

When any amplifier unit is NG, the integrated judgment is NG.

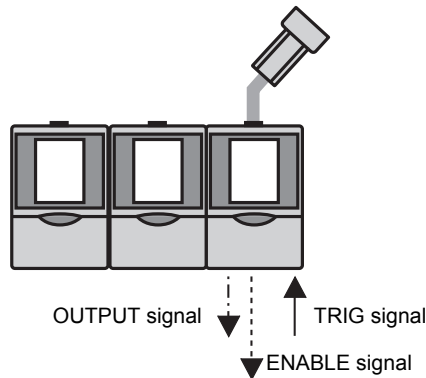

■ When judgment results are output by each amplifier unit (EACH)

Select [EACH] to output judgment results by each amplifier unit. The host device ENABLE signal is enabled. Obtain OUTPUT signal after ENABLE signal is set to ON.

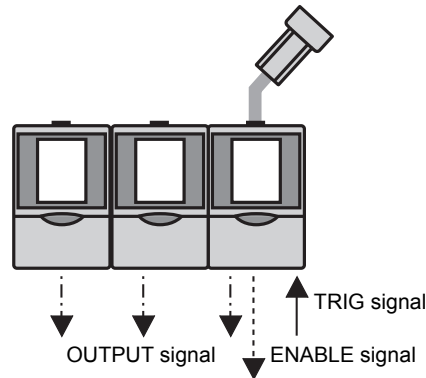

Restrictions when Gang-Mounting Amplifier Units

■ ZFV-A__ Gang-mounting units

The ZFV-A__ units cannot be gang-mounted.

■ ZFV-CA Gang-mounting multiple units

To use two or more ZFV-CA units by gang-mounting them to each other, the following hardware and software are required:

Hardware: Amplifier unit with serial number;

ZFV-CA40: 0218206 or bigger

ZFV-CA45: 0003206 or bigger

Software: Firmware version 1.30 or later

■ ZS-DSU Gang-mounting

To gang-mount the ZS-DSU and ZFV-CA units, the following software is required:

ZS-DSU: Firmware version 2.220 or later

ZFV-CA: Firmware version 1.30 or later



CHECK!

A maximum of five ZFV-CA units can be gang-mounted to a ZS-DSU unit.

Note, however, that any other unit (ZS-HLDC/LDC/MDC, ZFV-A) cannot be connected between the ZFV-CA and ZS-DSU units.

Section 6

APPENDIX

☒ Troubleshooting	118
☒ Error Messages and Corrective Actions	119
☒ Q&A	120
☒ Specifications and External Dimensions	121
☒ LED Safety Precautions for Using Laser Equipment	135
☒ Requirements from Regulations and Standards	136
☒ Updating the Firmware	140
☒ Version upgrade information	145
☒ Index	146

Troubleshooting

This section describes countermeasures for temporary hardware problems. Check the malfunction in this section before sending the hardware for repair.

Problem	Probable cause and possible countermeasure	Page
OUTPUT indicator does not lit.	<ul style="list-style-type: none"> Check the setting of [SYS2]-[OUTPUT]-[ONSTATUS]. To lit the indicator (OUTPUT signal ON) when the judgment is OK, select [OK ON], and to lit the indicator (OUTPUT signal ON) when the judgment is NG, select [NG ON]. 	p.107
RUN indicator does not lit.	<ul style="list-style-type: none"> Is the operating mode switch set to "RUN"? 	p.27
Dark LCD screen	<ul style="list-style-type: none"> Is the "Eco" mode function set? The "Eco" mode is set if pressing any key automatically returns to the original brightness. The brightness is maintained when the "Eco" mode setting is canceled. Note, however, that the life of the LCD backlight is shortened. So, we recommend setting the "Eco" mode. 	p.98
Images are not displayed.	<ul style="list-style-type: none"> Is the Sensor Head connector connected correctly? Is the brightness of the LED light set to a dark value? 	p.51 p.92
Screen is not displayed when amplifier units are gang-mounted.	<ul style="list-style-type: none"> Is power turned ON to all the gang-mounted amplifier units simultaneously? 	p.21
Measurement results are not displayed.	<ul style="list-style-type: none"> Is the operating mode switch set to "RUN"? 	p.27
The TRIG signal (input signal) is not accepted.	<ul style="list-style-type: none"> Are all cables connected correctly? Is the signal line disconnected? Is the operating mode switch set to "RUN"? 	p.39 p.27
The OUTPUT signal is not output.	<ul style="list-style-type: none"> Is the TRIG signal being input? Are all cables connected correctly? Is the signal line disconnected? Is the operating mode switch set to "RUN"? 	p.39 p.27
The ENABLE signal does not turn ON.	<ul style="list-style-type: none"> Is the operating mode switch set to "RUN"? 	p.27
The bank is not switched even if the bank switching signal is input from the outside.	<ul style="list-style-type: none"> Is the bank switching method set to [I/O]? When the bank switching method is set to [KEY], the external inputs of the BANK 1 to 3 are not accepted. Is the operating mode switch set to "RUN"? 	p.95 p.27
No communications with personal computer.	<ul style="list-style-type: none"> Is the USB cable is connected correctly. Is the RS-232C cable connected correctly? Are any other applications using the port on the personal computer? Are the same communication conditions are set to both personal computer and Amplifier Unit? Has the USB driver been installed? Is the Amplifier Unit operating correctly? 	p.102





Error Messages and Corrective Actions

Error Message	Cause	Countermeasure	Page
HEAD IS NOT CONNECTED	The Sensor Head is not connected correctly.	Make sure that the Sensor Head is connected correctly.	p.51
NEIGHBOR UNIT IS NOT CONNECT	The Amplifier Units are not coupled correctly.	Make sure that the Amplifier Units are connected correctly.	p.36
SYSTEM ERROR	Failed to configure FPGA. Failed to initialize LCD. Failed to recognize Amplifier Unit. Failed to load data from flash memory. Faulty hardware operation Faulty software operation	Faulty Amplifier Unit Contact your OMRON representative.	-
TEACHING FAILED	The workpiece is not projected correctly. The teaching area is not set at the appropriate position.	Set the area so that the workpiece is projected in the field-of-view. Make sure that the appropriate teaching area is set.	p.47
COLOR EXTRACTION FAILED	Teaching cannot be performed since no color pickup setting has been made.	Make color pickup setting (color), then perform teaching again.	p.61 p.152 p.158
DIFFERENT PASS NUMBER	The lock function cannot be cancelled because of an incorrect pass number.	Input the registered pass number.	p.105
SYSTDATA ERROR	Data saved to the instrument has been damaged.	The currently set system data is cleared. Set the system data again.	p.96
BANKDATA ERROR	The current bank data has been damaged.	The currently set bank data is cleared. Set the bank data again.	p.94
HEAD ERROR	Failed to communicate with the sensor head.	Make sure that the sensor head is connected correctly. High-voltage lines and power lines must be wired separately from this product.	-

In the following instances, error messages are not displayed, but the ERROR and ERR lmap turn ON.

Cause	Countermeasure	Page
TRIG was input while ENABLE was OFF.	Wait until ENABLE is turned ON and then input TRIG.	p.42
Failed to teach from external device.	Set the area so that the workpiece is projected in the field-of-view. Make sure that the appropriate teaching area is set. Make sure that TRIG timing is appropriate in the workpiece move teaching mode.	p.47 p.42

Q&A

Question	Answer
Can I turn LED light emission of the Sensor Head OFF?	<p>Yes, you can. Set [CUSTM]-[LIGHT] to [0000].</p> <p> p.92</p>
What should I do to set the measurement time as short as possible?	<p>There are two ways of setting a shorter measurement time:</p> <ul style="list-style-type: none"> • Set [SYS1]-[SPEED] to [MAX]. However, measurable screen range will be narrowed. <p> p.96</p> <ul style="list-style-type: none"> • Switch the screen display during measurement to "Display only image". The measurement time can be reduced proportionate to the reduction in display time. <p> p.54</p>
Teaching is not going well. What should I do?	<ul style="list-style-type: none"> • Workpiece move teaching A probable cause is that the workpiece is not properly in the teaching area as intended. Change to the workpiece stop teaching mode or teaching by key operation. • A probable cause is that teaching is not successful because an image is too dark or too bright. Adjust light emission at [CUSTM]-[LIGHT] so that the workpiece is projected clearly, and execute teaching again. <p> p.92</p> <ul style="list-style-type: none"> • Is a screen other than the MOVE and SIZE screens displayed for the teaching area? Teaching cannot be performed from the MOVE screen or SIZE screen. Set the position or size with the SET key, go back 1 screen up then press the teaching button.
At what timing are set measurement conditions saved to the amplifier unit?	<p>Set measurement conditions are saved to the amplifier unit "when external TEACH signal teaching is successful" or "when switched to RUN mode."</p> <p>When the TEACH key is pressed from the teaching screen to teach, contents will not be saved unless switched to RUN mode once. Changed contents, including teaching results, are cleared when switching off without saving.</p>
Search is performed outside search area even if search area for [SEARCH]/[MATCH] is changed.	<p>If the custom settings have been changed, perform teaching again.</p>

Specifications and External Dimensions

Sensor Head

ZFV-SC10 (Narrow View)

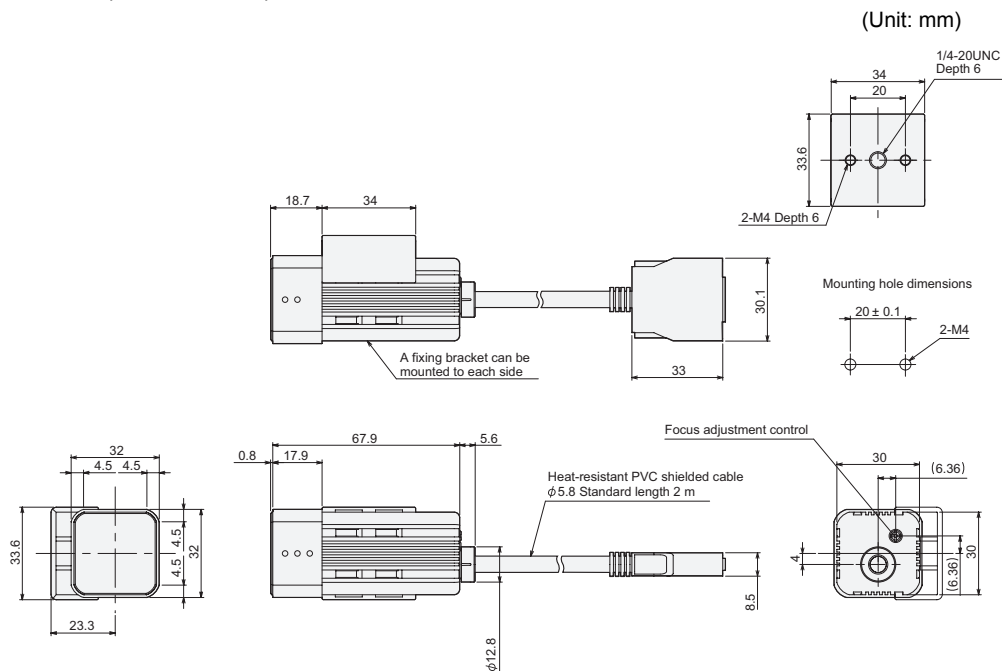

Section 6 Specifications and External Dimensions

ZFV-SC50/SC50W (Standard View)

(Unit: mm)

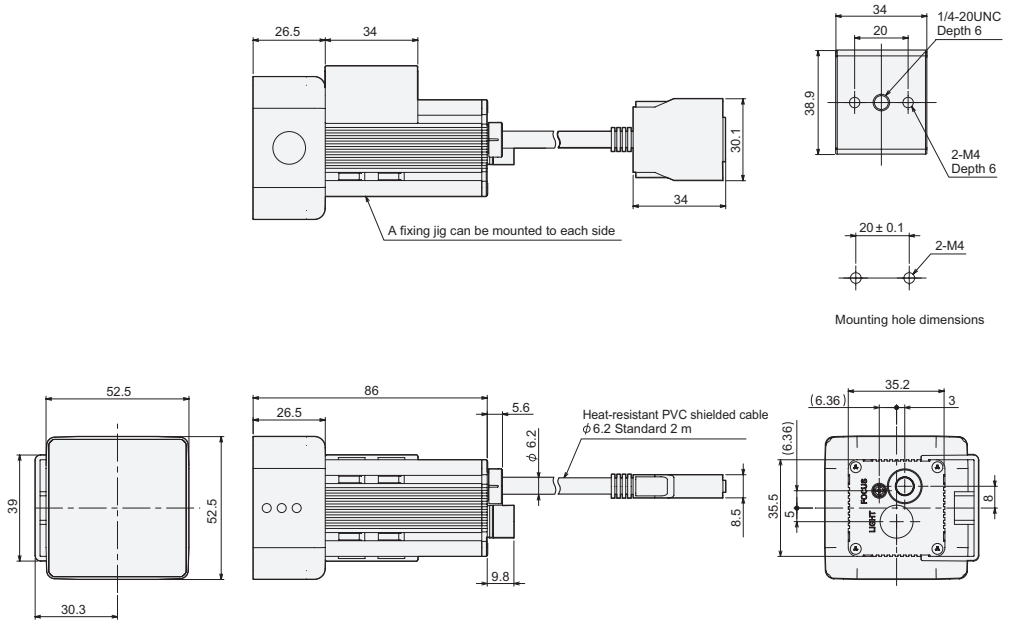

ZFV-SC90/SC90W (Wide View)

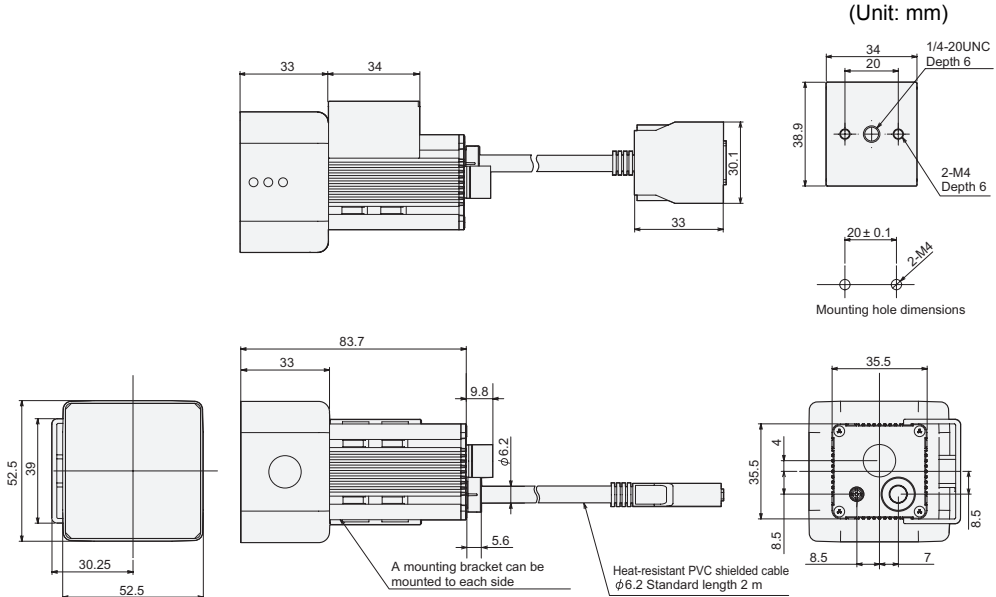

Section 6 Specifications and External Dimensions

ZFV-SC150/SC150W (Ultra Wide View)

(Unit: mm)

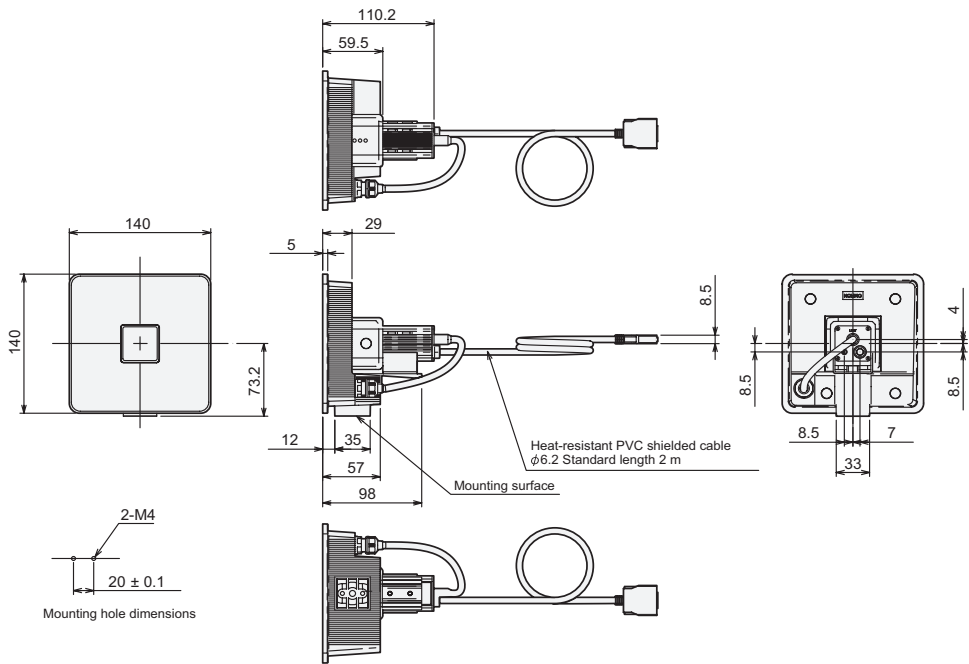

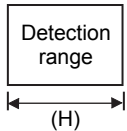
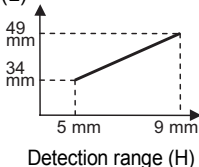
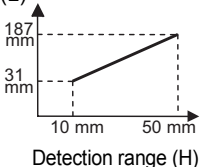
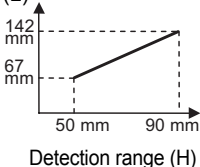
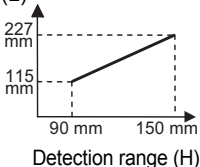
Item	ZFV-SC10 (Narrow View)	ZFV-SC50/SC50W (Standard View)	ZFV-SC90/SC90W (Wide View)	ZFV-SC150/SC150W (Ultra Wide View)
Setting distance (L)	34 to 49 mm (variable)	31 mm to 187 mm (variable)	67 to 142 mm (variable)	115 mm to 227 mm (variable)
Detection range (H×V)  (V) (H)	5 mm × 4.6 mm to 9 mm × 8.3 mm (Variable)	10 mm × 9.2 mm to 50 mm × 46 mm (Variable)	50 mm × 46 mm to 90 mm × 83 mm (Variable)	90 mm × 83 mm to 150 mm × 138 mm (Variable)
Relation between setting distance and detection range	Setting distance (L) 	Setting distance (L) 	Setting distance (L) 	Setting distance (L) 
Built-in lens	Focus: f15.65	Focus: f13.47	Focus: f6.1	
Object lighting method	Pulse lighting			
Object light source	Eight white LEDs	36 white LEDs	20 white LEDs	72 white LEDs
Lighting I/F (Option)	None	Yes	None	
Sensing element	1/3-inch color CCD			
Shutter	Electronic shutter shutter time: 1/500 to 1/8000			
Power supply voltage	15 VDC (Supplied from Amplifier Unit.)	15 VDC, 48 VDC (Supplied from Amplifier Unit.)		
Current consumption	Approx. 200 mA	Approx. 350 mA [15 V: Approx. 150 mA, 48 V: Approx. 200 mA] (Including the current consumed when optional lighting is connected)		
Dielectric strength	1,000 VAC, 50/60 Hz for 1 min			
Vibration resistance (destructive)	10 to 150 Hz, 0.35 mm single amplitude, 10 times each in X, Y, and Z directions for 8 min			
Shock resistance (destructive)	150 m/s ² , three times each in six directions (up/down, left/right, forward/backward)			
Ambient temperature	Operating: 0 to +40 °C, Storage: -20 to +65 °C (with no icing or condensation)			
Ambient humidity	Operating and storage: 35 % to 85 % (with no condensation)			
Ambient atmosphere	Must be free of corrosive gas.			
Connection type	Prewired, Standard cable length: 2 m			
Degree of protection (IEC60529)	IP65	ZFV-SC___: IP65 ZFV-SC___W: IP67		
Material	Case: ABS, Mounting bracket: PBT			
Weight	Approx. 200 g (including mounting bracket and cord) (When packaged: Approx. 300 g)	Approx. 270 g (including mounting bracket and cord) (When packaged: Approx. 350 g)	Approx. 300 g (including mounting bracket and cord) (When packaged: Approx. 380 g)	Approx. 600 g (including mounting bracket and cord) (When packaged: Approx. 780 g)
Accessories	Mounting bracket ZFV-XMF (1), Ferrite core (2), Instruction sheet	Mounting bracket ZFV-XMF2 (1), Ferrite core (2), Warning label (1), Instruction sheet	Mounting bracket ZFV-XMF2 (1), Ferrite core (2), Warning label (1), Instruction sheet	Ferrite core (2), Instruction sheet
LED class *1	Class 1	Class 2	Class 2	Class 1

*1 Applicable standards: IEC60825-1:1993 +A1:1997 +A2:2001, EN60825-1:1994 +A1:2002 +A2:2001

Amplifier Unit

ZFV-CA40/CA45

(Unit: mm)

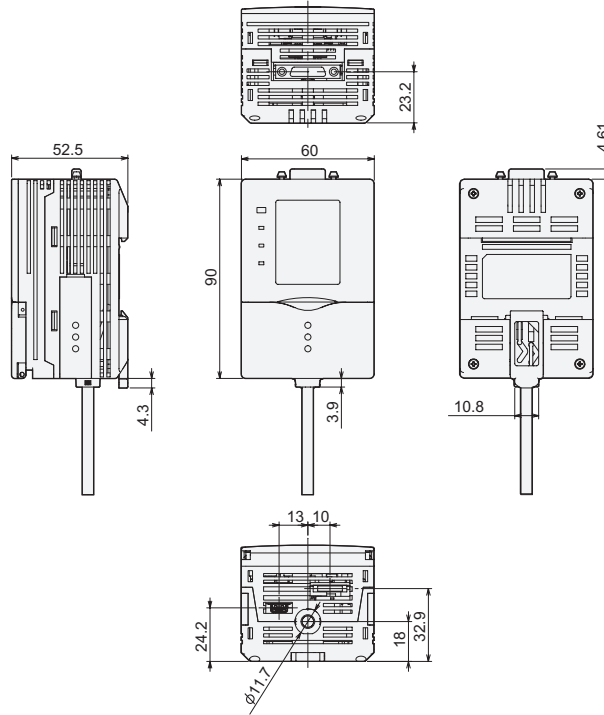

Item		ZFV-CA40	ZFV-CA45
Output specifications		NPN open-collector, 30 VDC, 50 mA max., Residual voltage: 1.2 V max.	PNP open-collector, 50 mA max., Residual voltage: 1.2 V max.
Input specifications	ON	Short-circuited with 0 V terminal or 1.5 V or less	Supply voltage short-circuited or within supply voltage -1.5 V max.
	OFF	Open (leakage current: 0.1 mA max.)	Open (leakage current: 0.1 mA max.)
Serial I/O	USB2.0	1 Port, FULL SPEED [12Mbps], MINI-B	
	RS-232C	1 Port, 115200 bpsmax.	
Inspection items		PATTERN, AREA, HUE(Color), WIDTH, POSITION, COUNT, BRIGHT, CHARA	
Teaching area		Rectangular, one area	
Teaching area size		<ul style="list-style-type: none"> • PATTERN, BRIGHT: Any rectangular area (256 × 256 max.) • AREA, HUE(Color), WIDTH, POSITION, COUNT, CHARA: Any rectangular area (max. full screen) 	
Sensing area		Full screen	
Resolution		468 (H) × 432 (V) max.	
Bank switching		Supported for 8 banks.	
Image input interval		13 ms (Standard), 8 ms (1/2 for partial scan), 5 ms (1/4 for partial scan)	
Other functions		Control output switching: ON for OK /ON for NG, ON delay / OFF delay, One-shot output, Eco mode	
Output signals		(1) Control output (OUTPUT) (2) Enable output (ENABLE) (3) Error output (ERROR)	

Item	ZFV-CA40	ZFV-CA45
Input signals	(1) Simultaneous measurement input (TRIG)/ Continuous measurement input (TRIG) switched by menu. (2) Bank selection inputs (BANK1-3) (3) Workpiece still teaching (TEACH)/Workpiece moving teaching (TEACH) Switched by menu	
Sensor Head interface	Digital interface	
Image display	1.8-inch TFT color LCD (557 × 234 pix)	
Indicators	<ul style="list-style-type: none"> • Judgment result indicator (OUT, orange) • Inspection mode indicator (RUN, green) • Error indicator (ERR, red) • READY indicator (READY, blue) 	
Operation interface	<ul style="list-style-type: none"> • Cursor keys (up, down, left, right) • Setting key (SET) • Escape key (ESC) • Operating mode switching (slide switch) • Menu switching (slide switch) • Teaching/Display switching key (TEACH/VIEW) • Function keys (A to D 4 input) 	
Power supply voltage	20.4 to 26.4 VDC (including ripple)	
Current consumption	800 mA max. (with Sensor Head connected)	
Dielectric strength	1,000 VAC, 50/60 Hz for 1 min between leads and Amplifier Unit case	
Noise Resistance	1 kV, Pulse rise: 5 ns, Pulse width: 50 ns, Burst duration: 15 ms Cycle: 300 ms	
Vibration resistance (destructive)	10 to 150 Hz, 0.1 mm single amplitude, 10 times each in X, Y, and Z directions for 8 min	
Shock resistance (destructive)	Destruction: 150 m/s ² , three times each in six directions (up/down, left/right, forward/backward)	
Ambient temperature range	Operating: 0 to +50 °C, Storage: -25 to +65 °C (with no icing or condensation)	
Ambient humidity range	Operating and storage: 35 % to 85 %	
Ambient atmosphere	Must be free of corrosive gas.	
Degree of protection	IEC60529 IP20	
Material	Polycarbonate (PC)	
Weight	Approx. 300 g (including cord) (when packaged: approx. 450 g)	
Accessories	Ferrite core (1), Instruction sheet, Label (1)	

Panel Mount Adapters

ZS-XPM1/XPM2

When mounting on a panel

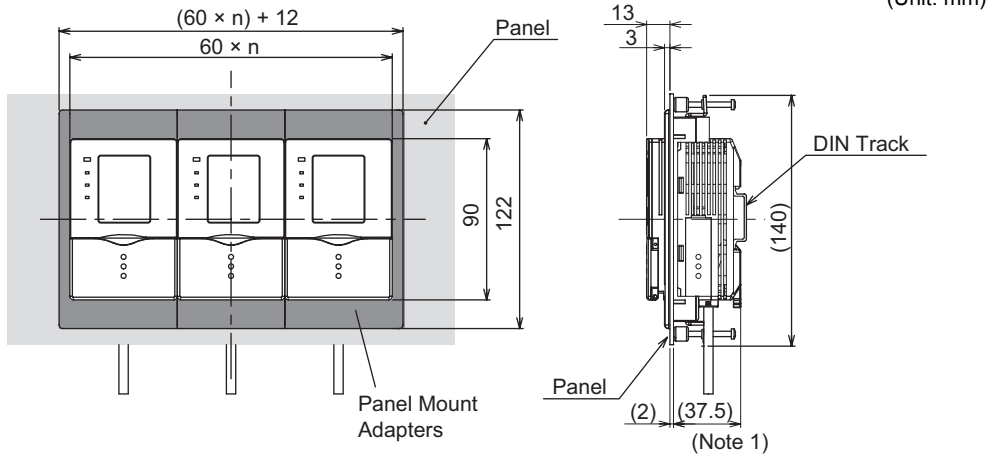

Note 1: Dimensions when the panel thickness is 2.0 mm

Panel cutout dimensions

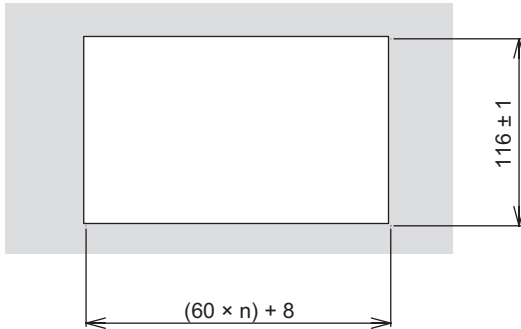

n: Number of connected controllers (1 to 10)

Item	ZS-XPM1 (for 1st unit)	ZS-XPM2 (for 2nd unit onwards)
Appearance		
Vibration resistance (destructive)	10 to 150 Hz, 0.7 mm double amplitude, 80 min each in X, Y, and Z directions	
Shock resistance (destructive)	300 m/s ² 3 times each in six directions (up/down, left/right, forward/backward)	
Material	Polycarbonate (PC), etc.	
Weight	Approx. 50 g	

Control Link Unit

ZS-XCN

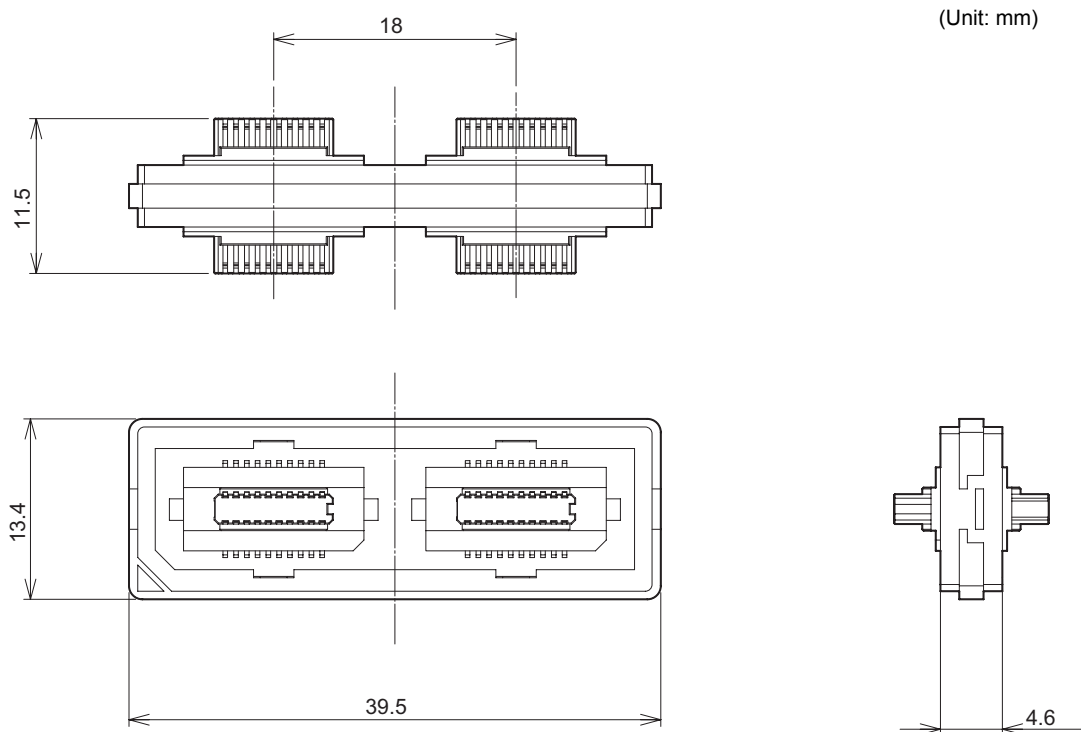

Item	ZS-XCN
Ambient temperature	Operating: 0 to +50 °C, Storage: -15 to +60 °C (with no icing or condensation)
Ambient humidity	Operating and storage: 35 % to 85 % (with no condensation)
Vibration resistance (destructive)	10 to 150 Hz, 0.7 mm double amplitude, 80 min each in X, Y, and Z directions
Shock resistance (destructive)	300 m/s ² 3 times each in six directions (up/down, left/right, forward/backward)
Material	Polycarbonate (PC), etc.
Weight	Approx. 10 g

Extension Cord

ZFV-XC_B(R)V2

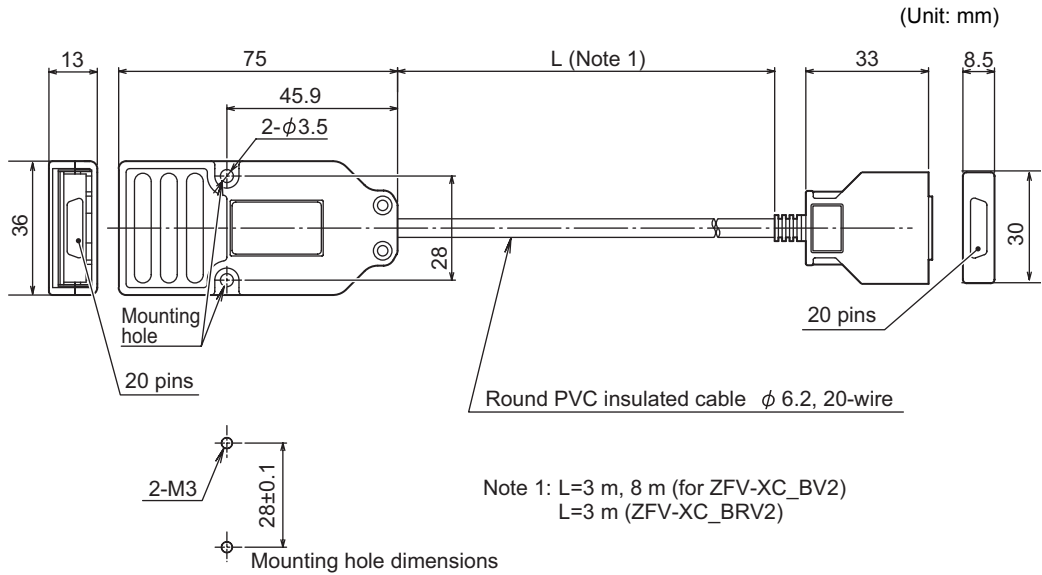

Item	ZFV-XC3BV2	ZFV-XC3BRV2*	ZFV-XC8BV2
Applicable Amplifier Units	ZFV-C Series		
Applicable Sensor Head	ZFV-SC10/SC50/SC50W/SC90/SC90W/SC150/SC150W		ZFV-SC10/SC50/SC50W
Ambient temperature	Operating: 0 to +40 °C, Storage: -25 to +65 °C (with no icing or condensation)		
Ambient humidity	Operating and storage: 35 % to 85 %(with no condensation)		
Connection type	Double-sided connector		
Material	Case: Polycarbonate (PC)		
Weight	Approx. 220 g	Approx. 220 g	Approx. 500 g
Cord length	3 m	3 m	8 m

* Model Nos. appended with R are robot cable types.

RS-232C Cable

ZS-XPT2 (for connecting a programmable controller)

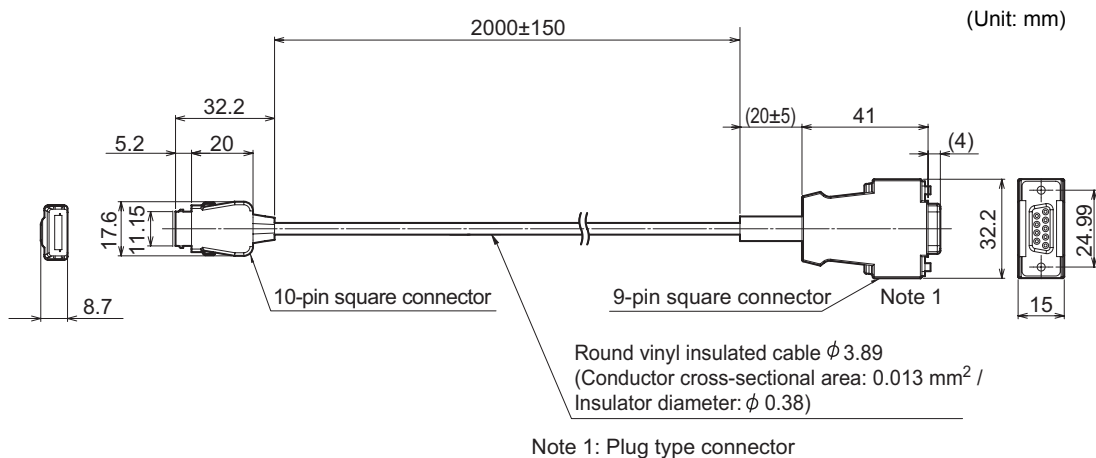

ZS-XRS2 (for connecting a personal computer)

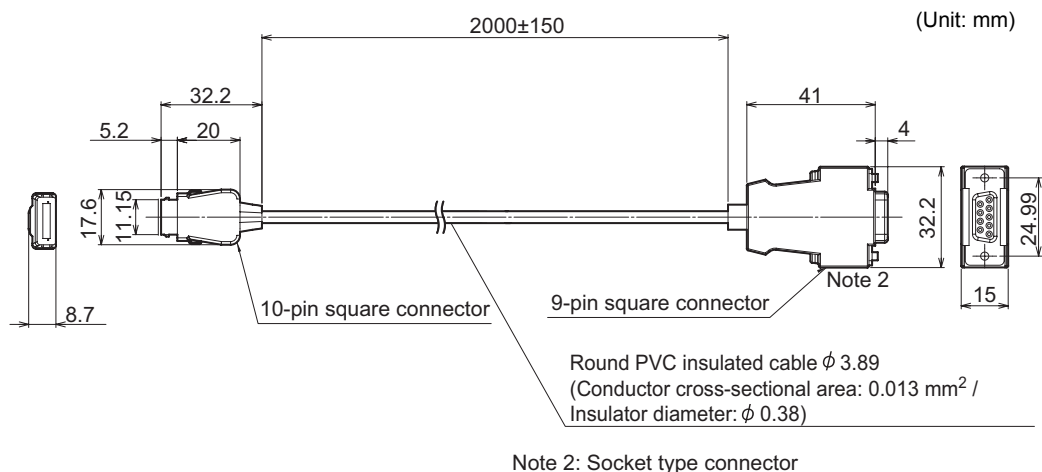

Item	ZS-XRS2	ZS-XPT2
Applicable Amplifier Units	ZFV-C Series	
Ambient temperature	Operating: 0 to +50 °C, Storage: -15 to +60 °C (with no icing or condensation)	
Ambient humidity	Operating and storage: 35 % to 85 % (with no condensation)	
Dielectric strength	1,000 VAC, 50/60 Hz for 1 min	
Insulation resistance	100 M Ω (at 500 VDC)	
Vibration resistance (destructive)	10 to 150 Hz (0.7 mm double amplitude), 80 min each in X, Y, and Z directions	
Shock resistance (destructive)	300 m/s ² 3 times each in six directions (up/down, left/right, forward/backward)	
Material	Cable sheath: Heat-resistant vinyl chloride (PVC)	
Weight	Approx. 50 g	

Lighting Unit (Option)

ZFV-LTL01 (bar lighting)

(Unit: mm)

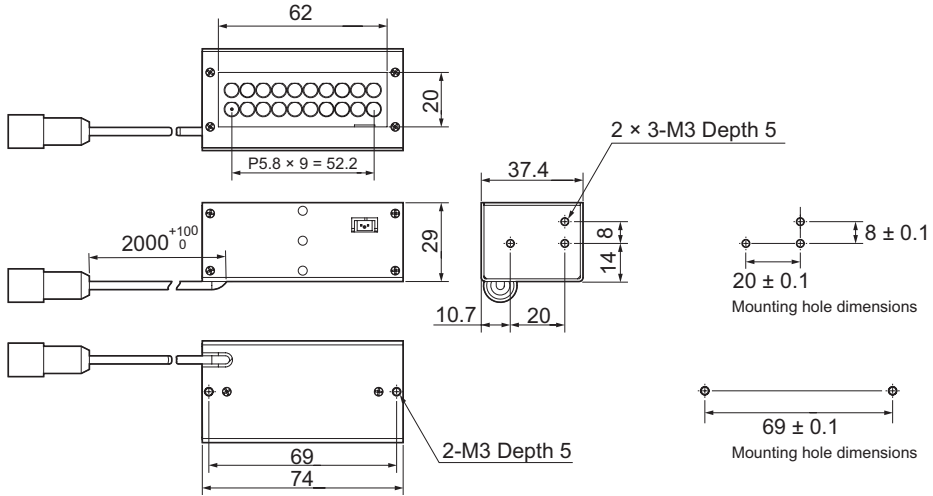

ZFV-LTL02 (bar double-lighting)

(Unit: mm)

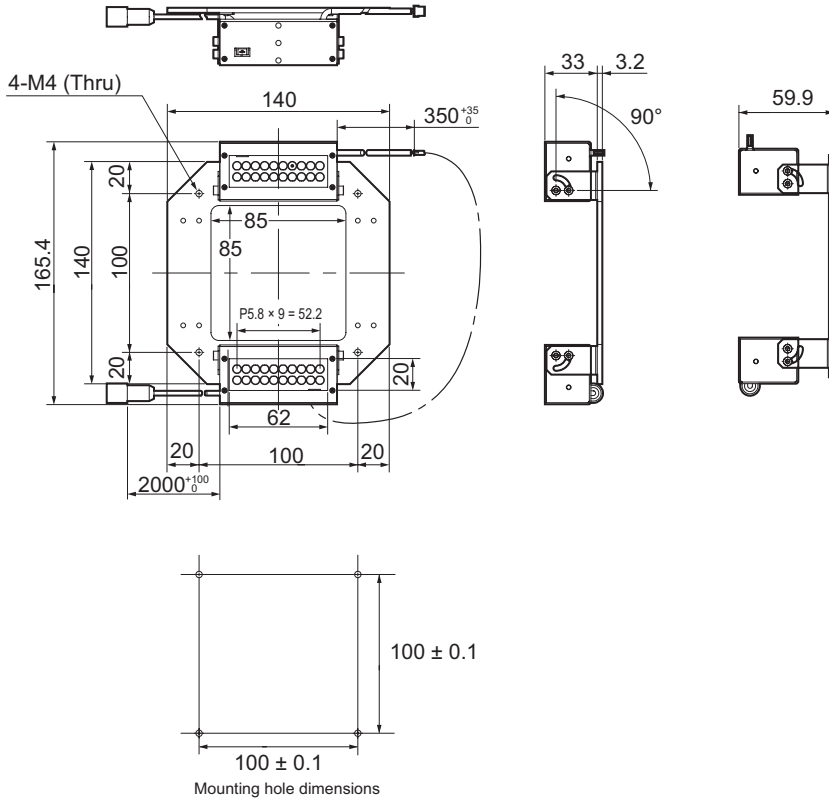

ZFV-LTL04 (bar low-angle lighting)

(Unit: mm)

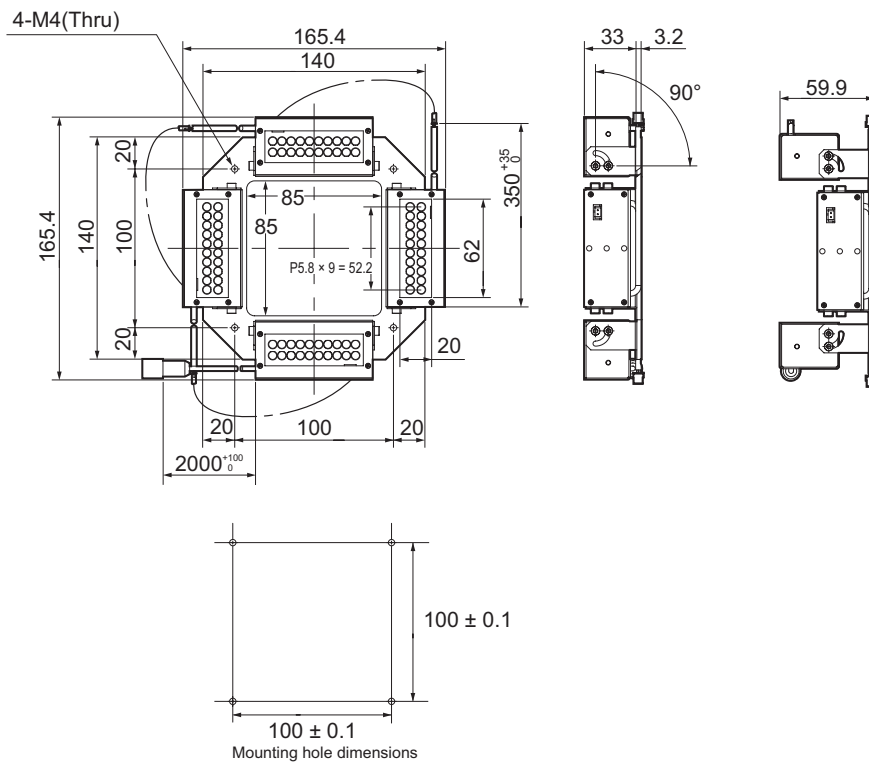

ZFV-LTF01 (light source for through-beam lighting)

(Unit: mm)

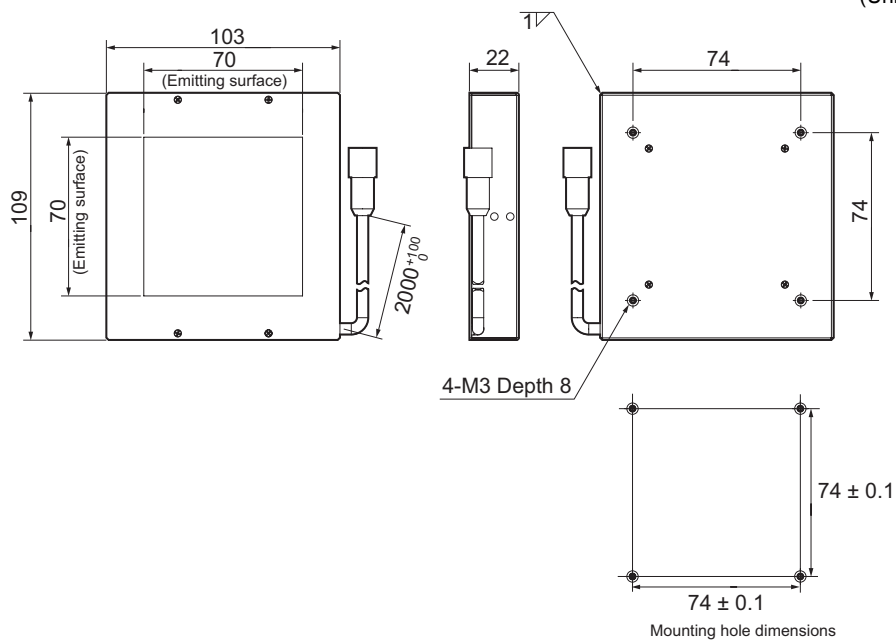

Section 6 Specifications and External Dimensions

Item	ZFV-LTF01	ZFV-LTL01	ZFV-LTL02	ZFV-LTL04
Applicable sensor head	ZFV-SC50/SC50W/SC90/SC90W			
Lighting method	Pulse lighting			
Lighting interval	Fixed (1.1 to 1.4 ms)			
Light source (Qty.)	White LEDs			
	60	20	40	80
Power supply voltage	48 VDC (Supplied from sensor head)			
Current consumption	Approx. 160 mA	Approx. 80 mA	Approx. 120 mA	Approx. 210 mA
Dielectric strength	300 VAC, 50/60 Hz for 1 min			
Vibration resistance (destructive)	10 to 150 Hz, 0.35 mm single amplitude, 10 times each in X, Y, and Z directions for 8 min			
Shock resistance (destructive)	150 m/s ² , 3 times each in six directions (up/down, left/right, forward/backward)			
Ambient temperature	Operating: 0 to +40 °C Storage: -20 to +65 °C (with no icing or condensation)			
Ambient humidity	Operating and storage: 35 % to 85 %RH (with no condensation)			
Ambient atmosphere	Must be free of corrosive gas			
Connection type	Prewired, Standard cable length: 2 m			
Degree of protection	IEC60529 IP20			
Material	SPCC	SPCC, aluminum		
Weight	Approx. 500 g (When packaged: Approx. 550 g)	Approx. 250 g (When packaged: Approx. 300 g)	Approx. 650 g (When packaged: Approx. 900 g)	Approx. 900 g (When packaged: Approx. 1,150 g)
LED class	Class 1 Applicable standards IEC60825-1: 1993 +A1: 1997 +A2: 2001 EN60825-1: 1994 +A1: 2002 +A2: 2001			

LED Safety Precautions for Using Laser Equipment

For LED devices, class classification to indicate dangerous level and safety standards are stipulated in respective countries.

Take necessary safety preventive measures according to the standards.

Class category

Standards and Class Classification (*1)	
JIS C 6802(Japan) EN60825/IEC60825-1 (Europe)	FDA (USA)
Class 2	(Exception)

(*1) Safety standards vary with the country in which the instrument is to be used (except for Japan, Europe and USA). Refer to the safety regulations and standards for laser devices stipulated in the country in which the instrument is to be used.

■ Labeling on LED use

Warning labels are supplied as accessories with the ZFV-SC50/SC50W/SC90/SC90W. Affix them to appropriate positions near the sensor where they can be easily noticed.

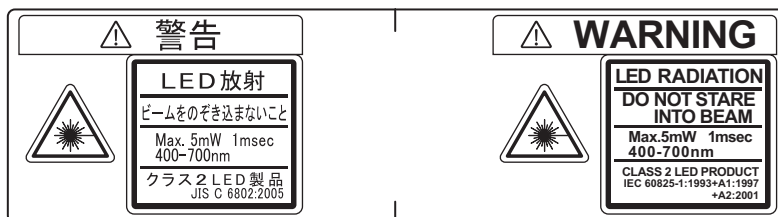

Requirements from Regulations and Standards

Summary of Requirements to Manufactures

■ For Europe

EN 60825-1 “Safety of Laser Products, Equipment Classification, Requirements and User’s Guide”

Summary of Manufacturer’s Requirements

Requirements subclause	Classification						
	Class 1	Class 1M	Class 2	Class 2M	Class 3R	Class 3B	Class 4
Description of hazard class	Safe under reasonably foreseeable conditions	As for Class 1 except may be hazardous if user employs optics	Low power; eye protection normally afforded by aversion responses	As for Class 2 except may be more hazardous if user employs optics	Direct intra-beam viewing may be hazardous	Direct intra-beam viewing normally hazardous	High power; diffuse reflections may be hazardous
Protective housing	Required for each laser product; limits access necessary for performance of functions of the products						
Safety interlock in protective housing	Designed to prevent removal of the panel until accessible emission values are below that for Class 3R				Designed to prevent removal of the panel until accessible emission values are below that for Class 3B		
Remote control	Not required					Permits easy addition of external interlock in laser installation	
Key control	Not required					Laser inoperative when key is removed	
Emission warning device	Not required				Give audible or visible warning when laser is switched on or if capacitor bank of pulsed laser is being charged. For Class 3R only, applies invisible radiation is emitted		
Attenuator	Not required					Give means beside the On/Off switch to temporarily to block beam	
Location controls	Not required				Controls so located that there is no danger of exposure to AEL above Classes 1 or 2 when adjustments are made		
Viewing optics	Not required	Emission from all viewing systems must be below Class 1M AEL					
Scanning	Scan failure shall not cause product to exceed its classification						
Class label	Required wording		Figures A required wording				
Aperture label	Not required				Specified wording required		
Service entry label	Required as appropriate to the class of accessible radiation						
Override interlock label	Required under certain conditions as appropriate to the class of laser used						

Requirements subclause	Classification						
	Class 1	Class 1M	Class 2	Class 2M	Class 3R	Class 3B	Class 4
Wavelength range label	Required for certain wavelength ranges						
LED label	Make required word substitutions for LED products						
User information	Operation manuals must contain instructions for safe use. Additional requirements apply for Class 1M and Class 2M						
Purchasing and service information	Promotion brochures must specify product classification; service manuals must contain safety information						

- Note:**
1. This table is intended to provide a convenient summary of requirements. See text of this standard for complete requirements.
 2. For the safety medical laser products, IEC 60601-2-22 applies
 3. AEL: Accessible Emission Limit
The maximum accessible emission level permitted within a particular class. For your reference, see ANSI Z136.1-1993, Section 2.

Symbol and border: black
Background: yellow

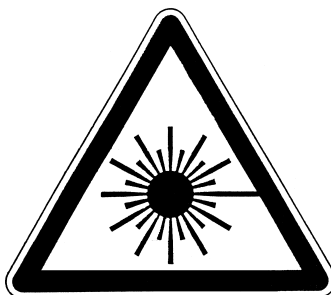

Figure A Warning label - Hazard symbol

Legend and border: black
Background: yellow

Summary of Requirements to User

■ For Europe

EN 60825-1

Requirements subclause	Classification						
	Class 1	Class 1M	Class 2	Class 2M	Class 3R	Class 3B	Class 4
Laser safety officer	Not required but recommended for applications that involve direct viewing of the laser beam				Not required for visible emission Required for non-visible emission	Required	
Remote interlock	Not required					Connect to room or door circuits	
Key control	Not required					Remove key when not in use	
Beam attenuator	Not required					When in use prevents inadvertent exposure	
Emission indicator device	Not required				Indicates laser is energized for non-visible wavelengths	Indicates laser is energized	
Warning signs	Not required					Follow precautions on warning signs	
Beam path	Not required	Class 1M as for Class 3B (see note 2)	Not required	Class 2M as for Class 3B (see note 3)	Terminate beam at end of useful length		
Specular reflection	No requirements	Class 1M as for Class 3B (see note 2)	No requirements	Class 2M as for Class 3B (see note 3)	Prevent unintentional reflections		
Eye protection	No requirements					Required if engineering and administrative procedures not practicable and MPE exceeded	
Protective clothing	No requirements					Sometimes required	Specific requirements
Training	No requirements	Class 1M as for Class 3R (see note 2)	No requirements	Class 2M as for Class 3R (see note 3)	Required for all operator and maintenance personnel		

Note: 1. This table is intended to provide a convenient summary of requirements. See text of this standard for complete precautions.

2. Class 1M laser products that failed condition 1 of table 10 of the standard. Not required for Class 1M laser products that failed condition 2 of table 10 of the standard. See the text for details.

3. Class 2M laser products that failed condition 1 of table 10 of the standard. Not required for Class 2M laser products that failed condition 2 of table 10 of the standard. See the text for details.

Definitions of Laser Classification

■ For Europe

Laser Product Classifications

EN

Class	Description
Class 1	Lasers which are safe under reasonably foreseeable conditions of operation.
Class 2	Lasers emitting visible radiation in the wavelength range from 400 nm to 700 nm. Eye protection is normally afforded by aversion responses including the blink reflex.
Class 3A	Lasers which are safe for viewing with the unaided eye. For laser emitting in the wavelength range from 400 nm to 700 nm, protection is afforded by aversion responses including the blink reflex. For other wavelengths the hazard to the unaided eye is no greater than for Class 1. Direct intrabeam viewing of Class 3A lasers with optical aides (e.g., binoculars, telescopes, microscopes) may be hazardous.
Class 3B	Direct intrabeam viewing of these lasers is always hazardous. Viewing diffuse reflections is normally safe (see note).
Class 4	Lasers which are also capable of producing hazardous diffuse reflections. They may cause skin injuries and could also constitute a fire hazard. Their use requires extreme caution.

Note: Conditions for safe viewing of diffuse reflections for Class 3B visible lasers are: minimum viewing distance of 13 cm between screen and cornea and a maximum viewing time of 10 s. Other viewing conditions require a comparison of the diffuse reflection exposure with the MPE.

Updating the Firmware

This section describes how to update the firmware of the ZFV-C Series Amplifier Unit. Warp Engine ZS is used to update the firmware.

For the file for updating, please contact your OMRON representative.



- Never turn OFF the power to the Amplifier Unit during update. Doing so will disable the Amplifier Unit's ability to start up correctly.
- When installing Warp Engine ZS, make a login as the administrator or a user, like a computer administrator who has the authority to change system settings.

Flow of Firmware Update

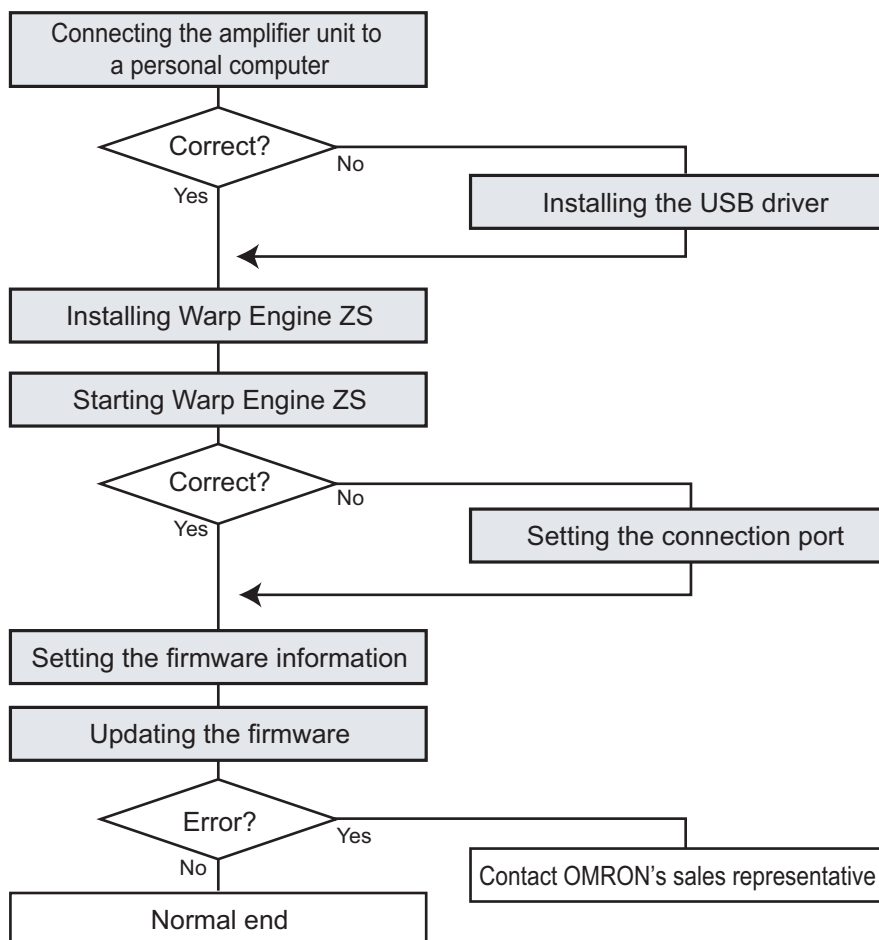

Connecting the amplifier unit Personal Computer

1. Connect the Amplifier Unit to the personal Computer with a USB cable.

When connecting the Amplifier Unit to a Personal computer for the first time, the USB driver must be installed in advance.

 Setting USB/RS-232C Communication Specifications p.102

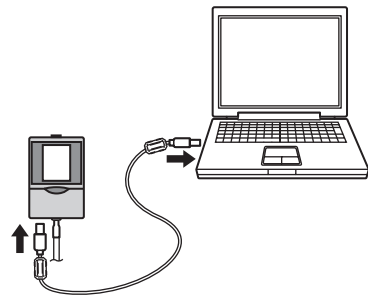

2. Turn ON the power supply to the Amplifier Unit.



- Make sure that power is supplied to the Amplifier Unit. If power is cut off during update, the Amplifier Unit will be damaged and will not start up correctly.
- When turning the power ON, always make sure that the Amplifier Unit is not connected to other Amplifier Units. If two or more Amplifier Units are connected, Warp Engine ZS will not start.

Starting Warp Engine ZS



- Do not start Warp Engine ZS unless the Amplifier Unit is recognized by the Personal Computer properly.

3. Select [Programs]-[OMRON]-[ZFV-C]-[WarpEngineZS]

From the [Start] menu on the Personal Computer.

The [WarpEngineZS] window will appear.

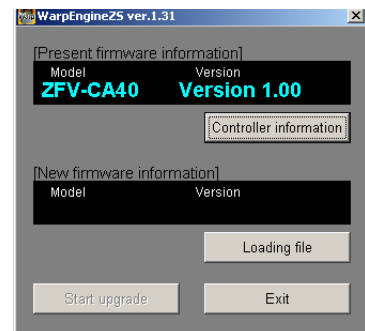

If you have failed to start Warp Engine ZS, a message will appear, followed by the dialog box shown on the right. Skip to “Setting the Connection Port”.



Setting the Firmware Information

4. Click the [Controller information] button if necessary.

The model and version number of the currently connected Amplifier Unit will be displayed.

5. Click the [Loading file] button to select the file to be written.

The Amplifier Unit model and version number registered in the file will be displayed.

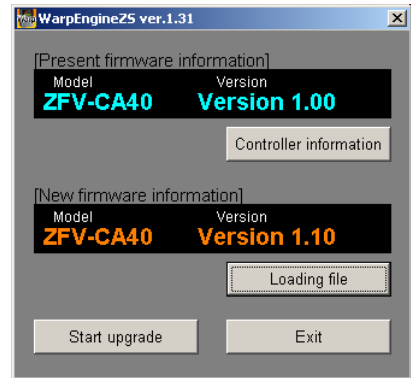

Performing Firmware Update

6. Click the [Start upgrade] button in the [WarpEngineZS] window.

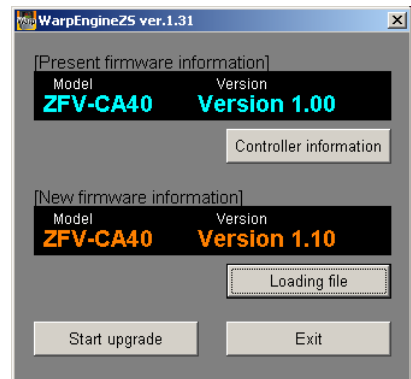

A message indicating that update is about to start will be displayed.



If a message "Different model" appears when the [Start upgrade] button is clicked, the currently connected Amplifier Unit does not match the model information registered in the file. In this case, never perform update. Doing so will damage the Amplifier Unit, disabling its ability to start up correctly any more.

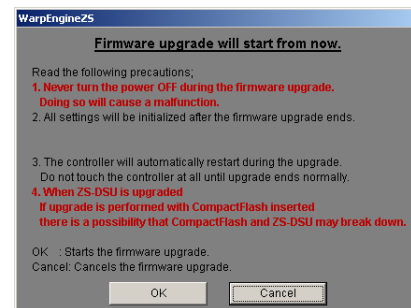

7. Check the message and click the [OK] button.

Firmware update will start.

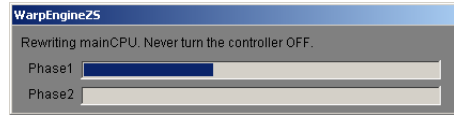

Progress of processing will appear during update. Wait until a message informing completion of update appears (update takes a couple of minutes).



- An error may occur with the Amplifier Unit during update, but ignore it.
- If the update progress bar stops or update is not completed within 10 minutes, there is a possibility that update has failed.
In this case, contact OMRON's sales representative about the firmware version before update and the one in the write file.

8. The following message will appear when update is complete, so follow the instructions given on the screen.



9. Check the message and click the [OK] button.

■ Setting the connection port

If you have failed to start Warp Engine ZS, a message will appear, followed by the dialog box shown on the right.

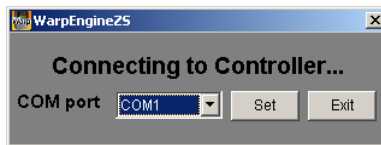

1. Select [Settings]-[Control Panel] from the [Start] menu of the personal computer, and then double-click [System].

The [System Properties] dialog box will appear.

2. Open the [Hardware] tab and click [Device Manager].

The [Device Manager] dialog box will appear.

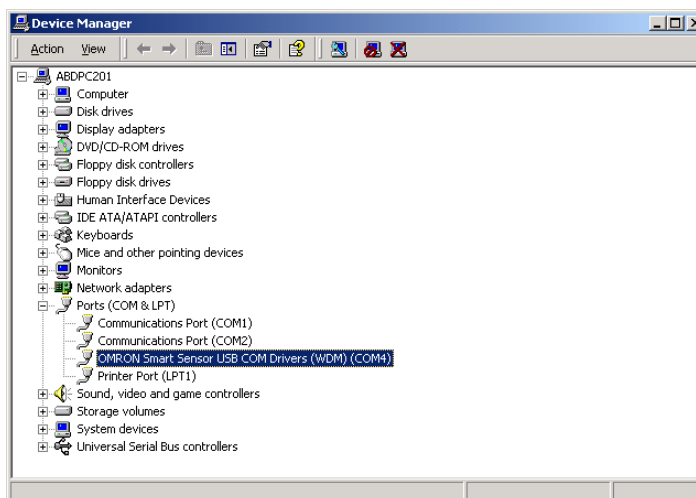

3. Open [Ports (COM&LPT)] and check the COM number in “OMRON Smart Sensor USB COM Drivers (WDM) (COMxx)”.

“COMxx” indicates the connection port of the Amplifier Unit.

4. Select the connection port of the Amplifier Unit from [COM Port], and click the [Set] button.

Warp Engine ZS will start.

Version upgrade information

Software version upgrade contents are explained.

■ Ver1.00 → Ver1.10

Changes	Page
Addition of [COL JUGE] for pattern inspection	p.65
Addition of horizontal direction ([DIRECTION] ← →) for width, position and count inspection	p.74, p.77, p.80
Addition of workpiece stop teaching function	p.97
Addition of still image teaching function	p.98

■ Ver1.10 → Ver1.20

Changes	Page
Addition of [AREA3] for area inspection	p.67
Addition of [CHARA] for character inspection	p.84
Addition of sensor sensitivity increase function	p.93
Addition of introduction of Smart Monitor ZFV Tool for personal computer	p.21

■ Ver1.20 → Ver1.30

Changes	Page
Addition of restrictions on Gang-Mounting Amplifier units	p.116
Addition of Lock function	p.105

Index

A

ADJ mode	27
Adjusting lighting	92
ALL CLEAR	100
Amplifier Unit	
Installation	32
Restrictions on gang-mounting	116
Specifications and External Dimensions	126
Amplifier unit expansion	22
Amplifier unit gang-mount	110
Area inspection	66
Area value	63, 68

B

Bank	
CLEAR	95
COPY	94
Switching	40, 58
Switching method	95
Basic Configuration	21
BINARY	69
Brightness check	81

C

CHARA	84
CLEAR	95
COL JUGE	65
COL MODE	74
COLOR	69
Color difference	71
Color Pickup Function	158
Color related items	
Changing the color mode	74
Changing the filter color	65
Color check	65
Light teaching	65
COM	102, 104
Connecting	
RS-232C	103
USB	102
CONTRAST	92
Control keys	57, 60
COPY	94
Correlation value	63, 86
COUNT	78
Count	79
Coupler	25

D

Density average value	82
Density deviation value	82
Density distribution value	86
Detection range	47, 125
DIRECTION	74, 77, 80, 89
DISP COL	97
DISP POS	93

E

ECO MODE	98
Edge level	73, 76, 79
EDGE MODE	74, 77, 80, 89
Edge position	76
Edge related items	
Hue	77, 80
Detection direction	74, 77, 80
Sensitivity	77
EDGE SENSE	77
Edge width	73
EXP menu	27
Expert menu	27
Extension Cord	130

F

Filter	65
Firmware	140, 145
Focus adjustment control	26

G

GAIN	93
Gang mounting	36

H

HEAD	111
HUE	70, 159

I

I/O Circuit diagrams	41
Initialization	
MEAS CLEAR	101
Measurement Data	101
Setting Data	100
Input cable	39
Input/output	
ON conditions	107
One-shot Output	107
Inspection contents	
Area	66
Brightness	81
Count	78

Detecting Presence of Character String (CHARA)	84	Output cable	39
Hue	70	OUTPUT TIME	108
Pattern	62		
Position	75	P	
Installation procedure		Part Names	
DIN Track	32	Amplifier Unit	24
Gang	36	Sensor Head	25
Panel	34	Partial function	93
		Pattern Inspection	62
K		Position check	75
Key Operations	60	Power Supply	21
MENU/ADJ mode	60		
RUN Mode	57	R	
		ROTATION	64
L		RS-232C	
LANGUAGE	101	Cable external dimensions	131
LIGHT TEACH	65	Cable wiring	103
Lighting Unit (Option)	132	Communication Setting	104
Lock Function	105	RUN Mode	27
M		S	
MDL DIV	87	SEARCH AREA	64, 90
MEAS TYPE	97	Sensor Head	
Measurement		Affixing LED Warning Labels	45
Measurement time	54	Connecting the Sensor Head	51
Speed adjustment	96	Focus adjustment	49
Switching the display content	54	Installing the Mounting Fixture	45
Timing	97	Sensitivity	93
MENU mode	27	Setting distance	47
Menu Hierarchy	16	Specifications and External Dimensions	121
Menu selector switch	24	Setting distance	47
Mode selector switch	24	SPEED	96
Menu switching	27	STABLE	90
METHOD	83	Standard menu	27
MODE	88	Standard View	125
MODEL	88	STD menu	27
		SWITCH	95
N			
Narrow View	125	T	
		TEACH IMAGE	98
O		TEACH TYPE	97
OFF DELAY	109	Teaching	
OFF delay time	109	AREA	68
ON DELAY	108	AREA1	68
ON delay time	108	AREA2	68
ON STATUS	107	BRIGHT	81
One-shot Output		COUNT	78
Continuous measurement	107	HUE	70
Output time	108	Match	63
Synchronous measurement	107	Pattern	63
Operation Mode	27	POSITION	75
Operational Flow	61	Search	63
OUTPUT	111	WIDTH	72

Workpiece move teaching	44
Workpiece stop teaching	43
Threshold	
AREA	68
AREA1	68
AREA2	68
BRIGHT	82
COUNT	79
HUE	71
Match	63
Pattern	63
POSITION	76
Search	63
WIDTH	73, 86
Timing Charts	
Synchronous measurement	42
Continuous measurement	42
TRIG	111
<hr/>	
U	
Ultra Wide View	125
USB	
Communication Setting	102
<hr/>	
V	
VERSION	101
<hr/>	
W	
Warp Engine ZS	140
WHITE BAL	100
Wide View	125
Width Inspection	72
Wiring	39

Section 7

APPLICATION AND SETTING

☒ Inspecting for the Presence of Electronic Components (Pattern)	150
☒ Detecting Mixed Varieties of Campaign Seals (Area)	152
☒ Inspecting Entry of Workpieces of Wrong Color (HUE)	156
☒ Explanation of Color Related Functions	158

Inspecting for the Presence of Electronic Components (Pattern)

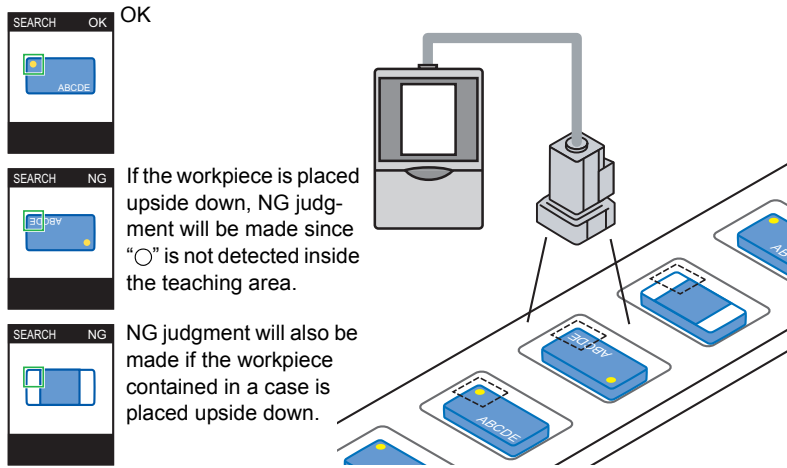

Adjusting the Camera

1. Adjust the camera so that the workpiece is displayed on the monitor.

Adjusting the Sensor Head Focus p.49

Setting the Inspection Method

2. Select and press the SET Key.

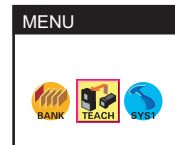
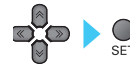

3. Select [ITEM] and press the SET Key.

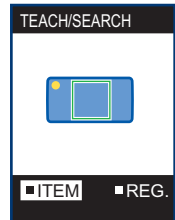

4. Select and press the SET Key.

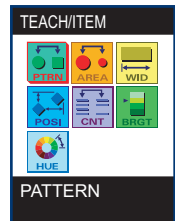

5. Select and press the SET Key.



Adjusting the Inspection Area

6. Select [REG.] and press the SET Key.

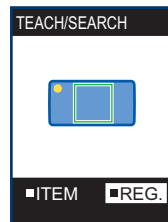

7. Adjust the size of the inspection area and press the SET Key.

Enlarge/reduce the window's green frame so that the inspection area is slightly larger than than the workpiece.

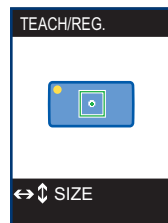
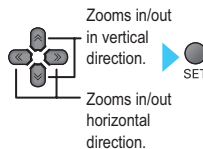

8. Adjust the position of the inspection area and press the SET Key.

Move the green frame so that the target is centered in the inspection area.

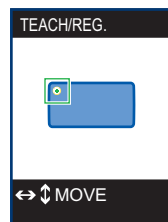
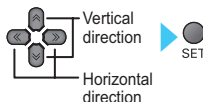

Registering the Reference Workpiece

9. Press the TEACH/VIEW key.

"+" will begin to blink at the center of the inspection area.

Teaching is completed when the "+" mark disappears.

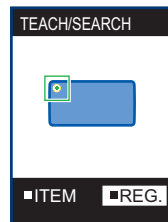

Checking Operation

10. Switch the mode switch to "ADJ mode".

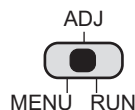

11. Check the measurement results displayed on the LCD monitor.

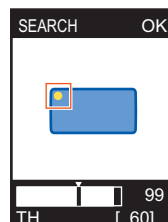

Detecting Mixed Varieties of Campaign Seals (Area)

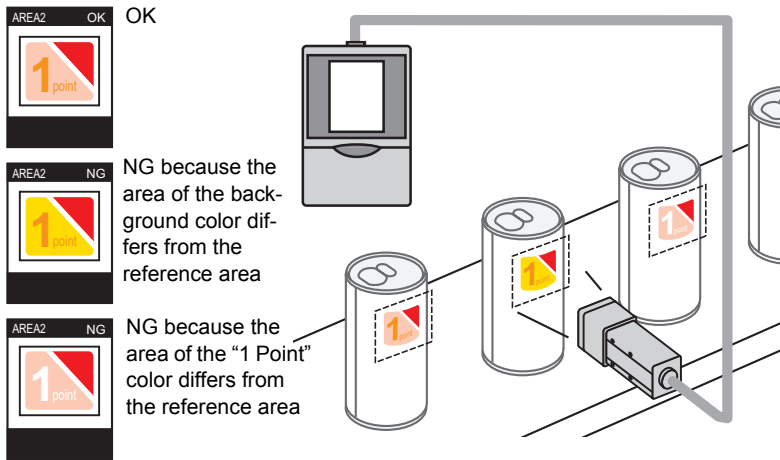

Adjusting the Camera

1. Adjust the camera so that the workpiece is displayed on the monitor.

Adjusting the Sensor Head Focus p.49

Setting the Inspection Method

2. Select and press the SET Key.

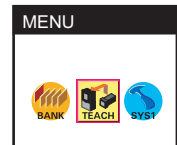
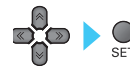

3. Select [ITEM] and press the SET Key.

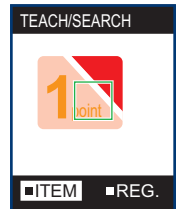

4. Select and press the SET Key.

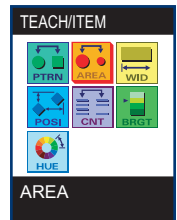

5. Select and press the SET Key.

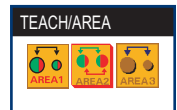

Adjusting the Inspection Area

6. Select [REG.] and press the SET Key.

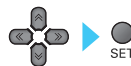

7. Adjust the size of the inspection area and press the SET Key.

Enlarge/reduce the screen's green frame so that the inspection area is slightly larger than than the workpiece.

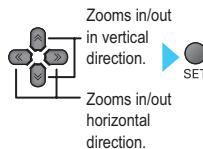

8. Adjust the position of the inspection area and press the SET Key.

Move the green frame so that the target is centered in the inspection area.

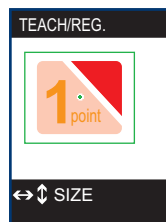
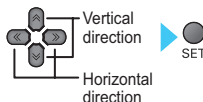

Selecting the Color to be Inspected

9. Select [PICK] and press the SET Key.

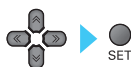

10. Select [PICKAREA] and press the SET Key.

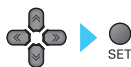

11. Adjust the size of the color pickup area and press the SET Key.

Enlarge/reduce the window's red frame of the screen so that the color to be selected is located inside the area.

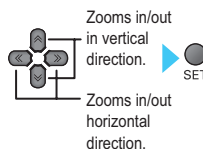

Section 7 Detecting Mixed Varieties of Campaign Seals (Area)

- 12. Adjust the position of the color pickup area and press the SET Key.**

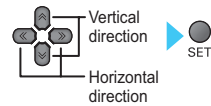

- 13. Select [PICKUP] and press the SET Key.**

Up to four colors are picked up automatically.

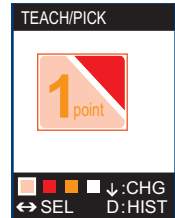

- 14. If there are colors that are not to be selected, use the ↓ key to add a “x” mark.**

← → Left/Right Keys: Move to left/right.

↓ Key: Switches a currently target object to a non-target object and a currently non-target object to a target object.



- 15. Press the SET Key.**

The selected colors will be confirmed.

- 16. Press the ESC Key.**

Registering the Reference Workpiece

- 17. Press the TEACH/VIEW key.**

“+” mark will appear at the center of the inspection area.

Teaching is completed when the “+” mark disappears.



Checking Operation

- 18. Switch the mode switch to “ADJ mode”.**

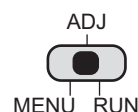

19. Check the measurement results displayed on the LCD monitor.

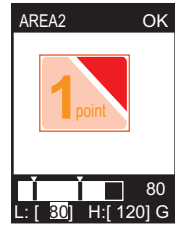

Inspecting Entry of Workpieces of Wrong Color (HUE)

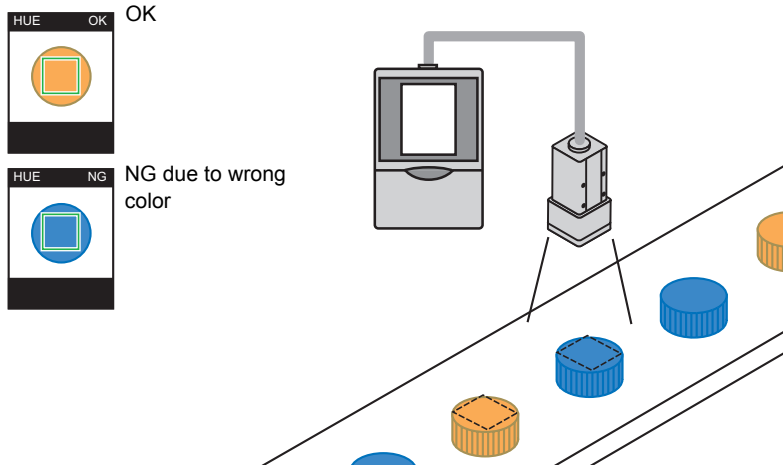

Adjusting the Camera

1. Adjust the camera so that the workpiece is displayed on the monitor.

 Adjusting the Sensor Head Focus p.49

Setting the Inspection Method

2. Select  and press the SET Key.

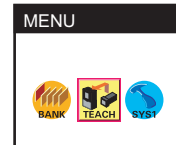

3. Select [ITEM] and press the SET Key.

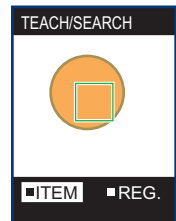

4. Select  and press the SET Key.

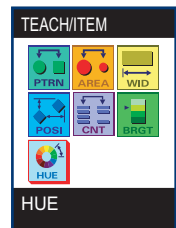

Adjusting the Inspection Area

5. Select [REG.] and press the SET Key.

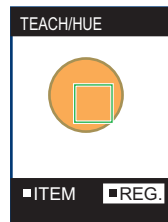

6. Adjust the size of the inspection area and press the SET Key.

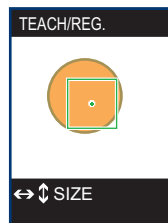
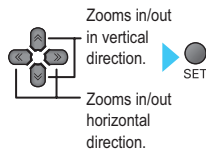

7. Adjust the position of the inspection area and press the SET Key.

Move the green frame so that the target is centered in the inspection area.

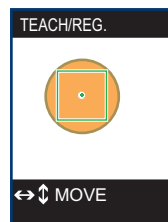
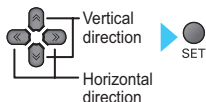

Registering the Reference Workpiece

8. Press the TEACH/VIEW key.

“+” mark will appear at the center of the inspection area.

Teaching is completed when the “+” mark disappears.

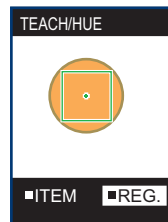

Checking Operation

9. Switch the mode switch to “ADJ mode”.

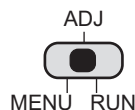

10. Check the measurement results displayed on the LCD monitor.

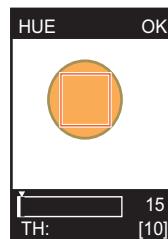

Explanation of Color Related Functions

Color Pickup Function

Up to four candidate colors (colors of the four largest areas) are picked up by simply enclosing the area to be measured.

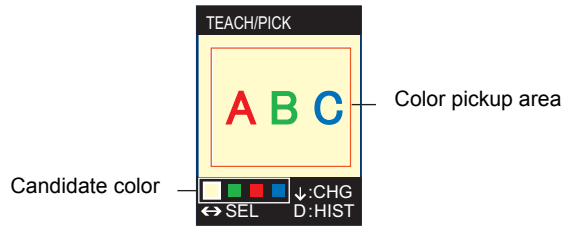

■ To check color pickup state

Pickup state of candidate colors can be viewed in histogram in the color pickup window.

In addition, pressing the [A] function key in a screen where an image is displayed switches the image between “color image”, “pickup image (color)” and “pickup image (monochrome)”.

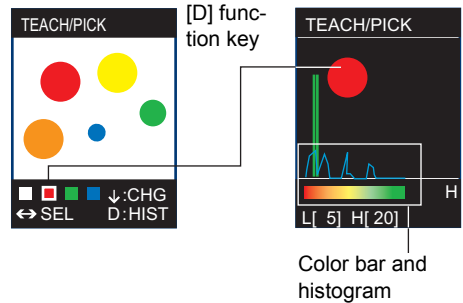

■ When color pickup is unstable

If color pickup cannot be performed properly (e.g. uneven colors), widen the target color range by monitoring the color bar and histogram.

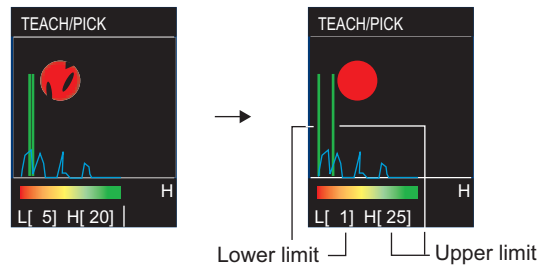

■ When there are four or more inspection target colors

Adjustment of the target color range is possible.

In this example, orange color can also be a target if the upper limit is raised.

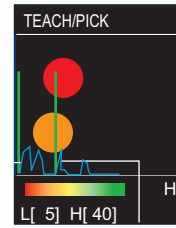

Hue Indication Number

For color inspection threshold values and upper/limit values (in the color pickup histogram screen), color range must be specified using hue indication numbers.

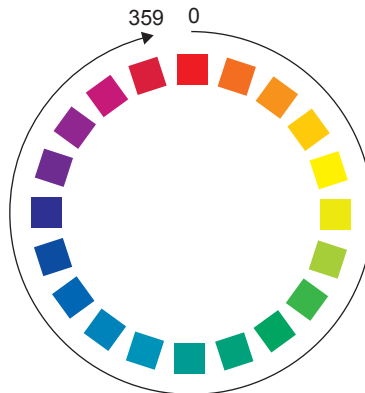

Revision History

A manual revision code appears as a suffix to the catalog number at the bottom of the front and back covers of this manual.

Cat. No. Z240-E2-03

↑
Revision code

Revision code	Date	Revised contents
01	2005. December	Original production
02	2006. February	<ul style="list-style-type: none">• Functions added as per software version upgrade (Ver1.20)• Addition of information for optional lighting unit• Corrections
03	2006. April	<ul style="list-style-type: none">• Functions added as per software version upgrade (Ver1.30)• Corrections